

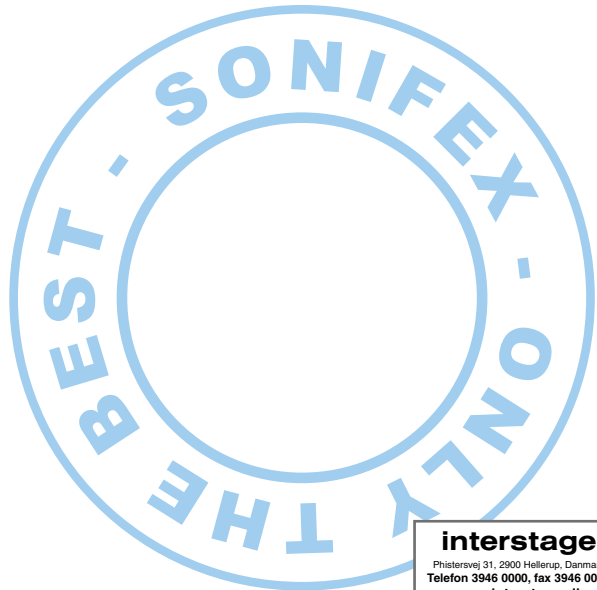

Reference Monitors User Handbook

- RM-2S4** Reference Monitor, 2 LED meters & 4 stereo channel inputs
- RM-2S10** Reference Monitor, 2 LED meters & 10 stereo channel inputs
- RM-4C8** Reference Monitor, 4 LED meters, 8 channel inputs & dual selectors
- RM-4C8-HDE1** Reference Monitor RM-4C8 With RM-HDE1 Dolby* Decoder Card
- RM-4C8-E1X** Reference Monitor RM-4C8 With RM-E1X Dolby* Decoder Card
- RM-4C8-E1B** Reference Monitor RM-4C8 With RM-E1B Dolby* Decoder Card
- RM-HD1** 3G/HD/SD-SDI expansion card
- RM-HDE1** 3G/HD/SD-SDI Dolby* E Decoder expansion card
- RM-E1X** Dolby* E Decoder expansion card
- RM-E1B** Dolby* E Decoder expansion card



interstage

Phistersvej 31, 2900 Hellerup, Danmark
Telefon 3946 0000, fax 3946 0040
www.interstage.dk



- pro audio with a smile





This handbook is for use with the following product:

- RM-2S4 Reference Monitor, 2 LED meters & 4 stereo channel inputs
- RM-2S10 Reference Monitor, 2 LED meters & 10 stereo channel inputs
- RM-4C8 Reference Monitor, 4 LED meters, 8 channel inputs & dual selectors
- RM-4C8-HDE1 Reference Monitor RM-4C8 With RM-HDE1 Dolby® Decoder Card
- RM-4C8-E1X Reference Monitor RM-4C8 With RM-E1X Dolby® Decoder Card
- RM-4C8-E1B Reference Monitor RM-4C8 With RM-E1B Dolby® Decoder Card
- RM-HD1 3G/HD/SD-SDI expansion card
- RM-HDE1 3G/HD/SD-SDI & Dolby® E Decoder expansion card
- RM-E1X Dolby® E Decoder expansion card
- RM-E1B Dolby® E Decoder expansion card

©Sonifex Ltd, 2009-2011
All Rights Reserved
Revision 1.16, November 2011

Sonifex Ltd, 61, Station Road, Irthlingborough,
Northants, NN9 5QE, England.
Tel: +44 (0)1933 650 700
Fax: +44 (0)1933 650 726
Email: sales@sonifex.co.uk
Website: <http://www.sonifex.co.uk>

Information in this document is subject to change without notice and does not represent a commitment on the part of the vendor. Sonifex Ltd shall not be liable for any loss or damage whatsoever arising from the use of information or any error contained in this manual.

No part of this manual may be reproduced or transmitted in any form or by any means, electronic or mechanical, including photocopying, recording, information storage and retrieval systems, for any purpose other than the purchaser's personal use, without the express written permission of Sonifex Ltd. Unless otherwise noted, all names of companies, products and persons contained herein are part of a completely fictitious adaptation and are designed solely to document the use of Sonifex product.

* Dolby and the double-D symbol are registered trademarks of Dolby Laboratories

Warranty	i
Warranty and Liability	i
Unpacking the Reference Monitor	iii
Returning the Warranty Card	iii
Safety Information	iv
Safety of Mains Operated Equipment	iv
Voltage Setting Checks	iv
Fuse Rating	iv
Power Cable and Connection	iv
Ordering the Correct Mains Lead	v
Installation Information	v
Atmosphere	v
Electromagnetic Radiation	v
WEEE & RoHS Directives - Sonifex Statement	vi
Reference Monitors Introduction	1
RM-2S4 Reference Monitor, 2 LED meters & 4 stereo channel inputs	3
RM-2S10 Reference Monitor, 2 LED meters & 10 stereo channel inputs	3
Introduction	3
System Block Diagram	4
Front Panel Indicators & Controls	5
Audio Modifiers	12
Rear Panel Connections & Operation	14
Technical Specification RM-2S4 & RM-2S10	21
RM-4C8 Reference Monitor, 4 LED meters, 8 channel inputs & dual selectors	26
Introduction	26
System Block Diagram	27
Front Panel Indicators & Controls	28
Audio Modifiers	34
Rear Panel Connections & Operation	36
Technical Specification RM-4C8	40
RM-HD1 Reference Monitor 3G/HD/SD-SDI Expansion Card	45
Technical Specification For RM-HD1	46
RM-HDE1 Reference Monitor 3G/HD/SD-SDI & Dolby® E Expansion Card	47
Technical Specification For RM-HDE1	48
RM-E1X Dolby E Decoder XLR AES Expansion Card & RM-E1B Dolby E Decoder BNC Expansion Card For RM-4C8	49
Technical Specification For RM-E1X and RM-E1B	50
Fitting An Expansion Card	51
Reference Monitor RM-4C8 with an RM-E1X, RM-E1B or RM-HDE1 Dolby Decoder Expansion Card	52
Operation of The RM-4C8 With The RM-E1X or RM-E1B Fitted	52
Operation of The RM-4C8 With The RM-HDE1 Fitted	53
Downmix Mode	53
Program Select Mode	54
Multichannel Monitoring Mode	54
Dual Metering Split Scale	56
Serial Interface Commands & Responses Protocol	57
Serial Data Format	57
Remote Control Commands	57
Reference Monitor SCI Remote Control Software	62
Download the Latest SCI Software	62
Connecting Using USB Port	62
Connecting using the RS232 Serial Port	62
Using SCI For The First Time	62
SCI For Reference Monitors	64
Bank & Source Selection & Editing	64
Front Panel Modifiers	65
5 Band Parametric Equalizer	65
Firmware Updates	67
Dolby Metadata	67





Figures

Fig A: Packing List	iii	Fig 2-7a: Meter Labelling Options	31
Fig B: Power Connections	iv	Fig 2-8: Brightness Control	32
Fig C: Mains Lead Table	v	Fig 2-9: Phase Meter Display	32
Fig 1-1: RM-2S4 Reference Monitor Front Panel	3	Fig 2-10: Balance Control	32
Fig 1-2: RM-2S10 Reference Monitor Front Panel	3	Fig 2-11: Status LEDs	33
Fig 1-3: Reference Monitor Block Diagram	4	Fig 2-12: RM-4C8 Modifier Switches	34
Fig 1-4: RM-2S4 Front Panel Controls	5	Fig 2-13: RM-4C8 Rear	36
Fig 1-5: RM-2S10 Front Panel Controls	5	Fig 3-1: RM-HD1 Expansion Card	45
Fig 1-6: RM-2S4 Source Selector	5	Fig 3-2: RM-HD1 Block Diagram	45
Fig 1-7: RM-2S10 Source Selector	5	Fig 3-3: RM-HDE1 Expansion Card	47
Fig 1-8: RM-2S4 & RM-2S10 Meters	7	Fig 3-4: RM-HDE1 Block Diagram	47
Fig 1-9: RM-2S4 & RM-2S10 DIPswitch Settings	8	Fig 3-5: RM-E1B Expansion Card	49
Fig 1-10: Meter Labelling Options	9	Fig 3-6: RM-E1X Expansion Card	49
Fig 1-10a: German PPM Labelling Options	9	Fig 3-7: RM-E1X/B Block Diagram	50
Fig 1-11: Brightness Control	10	Fig 4-1: Dolby RM-4C8 Front Panel	52
Fig 1-12: Phase Meter Display	10	Table 4-1: Program Configurations For Dolby E	55
Fig 1-13: Balance Control	10	Fig 4-2: Dual Metering Chart	56
Fig 1-14: Status LEDs	11	Fig 6-1: SCi Launcher	62
Fig 1-15: RM-2S4 & RM-2S10 Modifier Switches	12	Fig 6-2: SCi Device Discovery Panel	63
Fig 1-16: Reference Monitor RM-2S4 Rear	14	Fig 6-3: SCi Device Information Panel	63
Fig 1-17: Reference Monitor RM-2S10 Rear	14	Fig 6-4: SCi Launcher Loaded	63
Fig 1-18: RM-2S4 & RM-2S10 DIPswitch Settings	15	Fig 6-5: SCi Main Screen Showing Dolby Digital Monitoring	64
Reference Monitor Volume & Balance Remote Control Diagram	19	Fig 6-6: SCi Main Screen Showing Dolby E Monitoring	64
Fig 2-1: RM-4C8 Reference Monitor Front Panel	26	Fig 6-7: SCi Main Screen Showing Dolby Digital Programs	65
Fig 2-2: Reference Monitor Block Diagram	27	Fig 6-8: SCi User EQ Screen	66
Fig 2-3: RM-4C8 Front Panel Controls	28	Fig 6-9: SCi Misc Screen	66
Fig 2-4: RM-4C8 Rotary Source Selectors	28	Fig 6-10: Dolby Screen Showing Dolby Digital Metadata	67
Fig 2-5: RM-4C8 Meters	30	Fig 6-11: Dolby Screen Showing Dolby E Metadata	67
Fig 2-6: RM-4C8 DIPswitch Settings	30		
Fig 2-7: German PPM Labelling Options	31		

Warranty

Warranty and Liability

Important: the purchaser is advised to read this clause

- 
- (a) The Company agrees to repair or (at its discretion) replace Goods which are found to be defective (fair wear and tear excepted) and which are returned to the Company within 12 months of the date of despatch provided that each of the following are satisfied:
- (i) notification of any defect is given to the Company immediately upon its becoming apparent to the Purchaser;
 - (ii) the Goods have only been operated under normal operating conditions and have only been subject to normal use (and in particular the Goods must have been correctly connected and must not have been subject to high voltage or to ionising radiation and must not have been used contrary to the Company's technical recommendations);
 - (iii) the Goods are returned to the Company's premises at the Purchaser's expense;
 - (iv) any Goods or parts of Goods replaced shall become the property of the Company;
 - (v) no work whatsoever (other than normal and proper maintenance) has been carried out to the Goods or any part of the Goods without the Company's prior written consent;
 - (vi) the defect has not arisen from a design made, furnished or specified by the Purchaser;
 - (vii) the Goods have been assembled or incorporated into other goods only in accordance with any instructions issued by the Company;
 - (viii) the defect has not arisen from a design modified by the Purchaser;
 - (ix) the defect has not arisen from an item manufactured by a person other than the Company.

In respect of any item manufactured by a person other than the Company, the Purchaser shall only be entitled to the benefit of any warranty or guarantee provided by such manufacturer to the Company.

- (b) In respect of computer software supplied by the Company the Company does not warrant that the use of the software will be uninterrupted or error free.
- (c) The Company accepts liability:
- (i) for death or personal injury to the extent that it results from the negligence of the Company, its employees (whilst in the course of their employment) or its agents (in the course of the agency);
 - (ii) for any breach by the Company of any statutory undertaking as to title, quiet possession and freedom from encumbrance.



- (d) Subject to conditions (a) and (c) from the time of despatch of the Goods from the Company's premises the Purchaser shall be responsible for any defect in the Goods or loss, damage, nuisance or interference whatsoever consequential economic or otherwise or wastage of material resulting from or caused by or to the Goods. In particular the Company shall not be liable for any loss of profits or other economic losses. The Company accordingly excludes all liability for the same.
- (e) At the request and expense of the Purchaser the Company will test the Goods to ascertain performance levels and provide a report of the results of that test. The report will be accurate at the time of the test, to the best of the belief and knowledge of the Company, and the Company accepts no liability in respect of its accuracy beyond that set out in Condition (a).
- (f) Subject to Condition (e) no representation, condition, warranty or other term, express or implied (by statute or otherwise) is given by the Company that the Goods are of any particular quality or standard or will enable the Purchaser to attain any particular performance or result, or will be suitable for any particular purpose or use under specific conditions or will provide any particular capacity, notwithstanding that the requirement for such performance, result or capacity or that such particular purpose or conditions may have been known (or ought to have been known) to the Company, its employees or agents.
- (g)
 - (i) To the extent that the Company is held legally liable to the Purchaser for any single breach of contract, tort, representation or other act or default, the Company's liability for the same shall not exceed the Price of the Goods.
 - (ii) The restriction of liability in Condition (g)(i) shall not apply to any liability accepted by the Seller in Condition (c).
- (h) Where the Goods are sold under a consumer transaction (as defined by the Consumer Transactions (Restrictions on Statements) Order 1976) the statutory rights of the Purchaser are not affected by these Conditions of Sale.

Unpacking the Reference Monitor

The Reference Monitor is shipped with the following equipment. Please check your packaging to ensure that you have all of the items below. If anything is missing, please contact the supplier of your equipment immediately.

Item	Quantity Reference Monitor
Reference Monitor	1
IEC mains lead fitted with moulded mains plug	1
Handbook and warranty card	1
Overlay sheet for metering	1
USB cable	1

Fig A: Packing List

Each Reference Monitor is shipped in protective packaging and should be inspected for damage before use. Where an item is found to have transit damage, notify the carrier immediately with all the relevant details of the shipment. Packing materials should be kept for inspection and also for if the product needs to be returned.

Returning the Warranty Card

In order to register the date of purchase so that we can keep you informed of any design improvements or modifications, it is important to complete the warranty registration document that is enclosed and return it to Sonifex Ltd in the UK.

For your own records you should write down the serial number (which can be found on the rear of the Reference Monitor).

Serial Number
---------------	-------



WARRANTY

Safety Information

Safety of Mains Operated Equipment



This equipment has been designed to meet the safety regulations currently advised in the country of purchase and it conforms to the safety regulations specified by use of the CE Mark.

Warning : There are no user serviceable parts inside the equipment. If you should ever need to look inside the unit, always disconnect the mains supply before removing the equipment covers.

Voltage Setting Checks

Ensure that the machine operating voltage is correct for your mains power supply by checking the box in which your Reference Monitor was supplied. The voltage is shown on the box label. The available voltage settings are 115V, or 230V. Please note that all Reference Monitors are either switchable between 115V and 230V, or have a universal power supply.

Fuse Rating

The Reference Monitor is supplied with a single fuse in the live conducting path of the mains power input. For reasons of safety it is important that the correct rating and type of fuse is used. Incorrectly rated fuses could present a possible fire hazard, under equipment fault conditions. The fuse rating for the Reference Monitor is:

230 or 115 V operation - 2A 5 x 20mm SB

The active fuse is fitted on the outside rear panel of the unit.

Power Cable and Connection

An IEC power connector is supplied with the Reference Monitor which has a moulded plug attached – this is a legal requirement. If no moulded plug has been supplied with your Reference Monitor, please contact your supplier, because an IEC connector is always supplied from the Sonifex factory.

If for any reason, you need to use the Reference Monitor with a different power cable, you should use the following wiring guidelines.

Wire Colour	Connection
Green, or green and yellow	Earth (E)
Blue, or black	Neutral (N)
Brown, or red	Live (L)

Fig B: Power Connections

Connect the equipment in accordance with the connection details and before applying power to the unit, check that the machine has the correct operating voltage for your mains power supply.

Important Note : The terminal marked on the rear panel must be earthed.

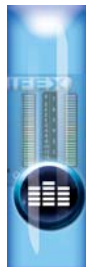

Ordering the Correct Mains Lead

When ordering a Reference Monitor from Sonifex, it is helpful if you can specify your required operating voltage and mains lead. After the product code add:

UK, for 230V, UK 3 pin to IEC lead



EC, for 230V, European Schuko 2 pin to IEC lead



US, for 115V, 3 pin to IEC lead



AU for 230V, Australasian 3 pin to IEC lead



Fig C: Mains Lead Table

E.g. order RM-2S4 UK for a UK IEC lead to be supplied.

Installation Information

Atmosphere

The units should be installed in an area that is not subject to excessive temperature variation ($<0^{\circ}\text{C}$, $>50^{\circ}\text{C}$), moisture, dust or vibration.

Electromagnetic Radiation

The cover is connected to earth by means of the fixing screws. It is essential to maintain this earth ground connection to ensure a safe operating environment and provide electromagnetic shielding.

WEEE & RoHS Directives - Sonifex Statement



The Waste Electrical and Electronic Equipment (WEEE) Directive was agreed on 13 February 2003, along with the related Directive 2002/95/EC on Restrictions of the use of certain Hazardous Substances in electrical and electronic equipment (RoHS).

The **Waste Electrical and Electronic Equipment Directive (WEEE)** aims to minimise the impacts of electrical and electronic equipment on the environment during their life times and when they become waste. It applies to a huge spectrum of products. It encourages and sets criteria for the collection, treatment, recycling and recovery of waste electrical and electronic equipment. All products manufactured by Sonifex Ltd have the WEEE directive label placed on the case. It gives a contact for individuals who are unsure about the correct procedure when the product has reached its “end of use”.

Sonifex Ltd will be happy to give you information about local organisations that can reprocess the products, or alternatively all products that have reached “end of use” can be returned to Sonifex and will be reprocessed correctly free of charge.

Sonifex Ltd has phased out the use of certain hazardous substances identified in the European Union’s **Restriction of Hazardous Substances (RoHS)** directive. The RoHS directive limits the use of certain hazardous substances currently used in EEE manufacture, including lead, mercury, cadmium, hexavalent chromium, and halide-containing compounds PBB (polybrominated biphenyl) and PBDE (polybrominated diphenyl ether). Elimination of these substances will result in more environmentally friendly recycling of electronic equipment. For the products which Sonifex manufacture, the main area where products were affected was in the use of lead for manufacturing and assembling electronics circuit boards.

Sonifex Ltd practices lead-free (LF) manufacturing processes. LF solder is used on the surface-mount PCB manufacturing processes and for hand soldering. The printed circuit boards (PCBs) used are either gold plated, or immersion tin plated, both of which use no lead. Historically the PCBs were hot air solder levelled (HASL) PCBs which used tin/lead based solder.

The manufacturing processes include the assembly of purchased components from various sources. Product is offered as RoHS compliant, or LF, only after sufficient evidence is received from the component manufacturers that their components are RoHS compliant. Sonifex Ltd relies solely on the distributor, or manufacturer, of the components for identification of RoHS compliance. Thus whilst every effort is made to ensure compliance, Sonifex Ltd makes no warranty, or certification, or declaration of compliance concerning said components.

Sonifex Ltd defines “Lead Free” as pertaining to any product, which has been manufactured by Sonifex Ltd using components which have been declared by the manufacturers as “Lead Free”. All statements by Sonifex Ltd of RoHS compliance are based on component manufacturer documentation.

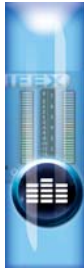



REFERENCE MONITOR



Reference Monitors Introduction

The Reference Monitor Range is a series of rack-mount audio monitors, combining the latest DSP technology with outstanding audio enclosure design to produce monitors of the highest standards with exceptional sound quality, a comprehensive feature set and good looks in the rack.

Uniquely an embedded 5 band parametric EQ allows you to configure the monitor for your environment or to suit your listening tastes.

Detail In The Design

In the design of the product, every care has been taken to ensure the best and most accurate reproduction of the audio sources.

In a 1U rack, the propagation of high power sound waves in such a small enclosure could have a tendency to produce rattles or move components, but the Reference Monitors have been designed to ensure that their audio performance is not compromised.

Anti-Vibration

A welded and sealed stainless-steel case with milled aluminium fascia provides exceptional rigidity and has been used to ensure that there are no extraneous metallic rattles. The lid is sealed with extensive thin foam cut-outs to provide damping to the lid and multi-point screw fixings are used to ensure lid rigidity.

The XLR and USB port connectors on the rear panel are sealed with foam, and silicon sealant is used on components which could move, or vibrate, under high SPL conditions.

Accurate Sound System

The speaker system comprises a three-way arrangement with two mid/high frequency speakers providing excellent stereo imaging and a separately driven, forward facing, dual magnet, mono bass driver.

Custom-moulded, profiled, HF enclosures are used to minimise standing waves and eliminate response peaks, and acoustic damping in the HF enclosures is used to reduce colouration, effectively creating a separate, sealed, infinite-baffle enclosure for each driver.

Each of the drivers is magnetically shielded so that the monitors are perfectly safe to

use near CRTs and TFT displays and each speaker uses a separate, highly efficient class-D switching amplifier.

Even cable lengths to and from the speaker enclosures have been kept short to reduce any potential microphonic induction.

DSP Based Design

The use of a modern electronic architecture allows a much better audio performance to be realised. The DSP-based, 3rd-order active crossover provides perfect separation between mid-range and bass sounds.

A DSP-based electronic equalisation is used to flatten the frequency response and also enables the 5 band parametric EQ. Additionally, the fast-attack DSP loudspeaker limiter protects the drivers from overload damage.

Audio Modifiers

Six illuminated soft-touch pushbuttons allow front panel muting and dimming of the loudspeakers, stereo-to-mono conversion, phase inversion and Middle+Side encoding/decoding with all front panel settings stored in non-volatile memory which is recalled at power-up. A universal power supply ensures global voltage operation without adjustment.

5 Band Parametric Equalisation

Each product in the Reference Monitor range contains an embedded 5 band parametric equaliser.

On testing the units, they are set up to give a flat response across the quoted frequency range, but the parametric EQ allows you to alter the response either to account for poor acoustics in the room that the monitor is mounted in, or to suit your particular listening tastes.

Using the free of charge SCi remote control software, preset EQ settings can be selected, or different EQ settings can be created and stored.

Front Panel Lock-Out

The controls on the front panel can optionally be locked out if required by using the free of charge SCi remote control software.

Optional Expansion Cards

These expansion cards allow the monitoring of audio in an 3G/HD/SD-SDI stream either as linear PCM or Dolby E and Dolby Digital encoded.

RM-HD1 3G/HD/SD-SDI expansion card

RM-HDE1 3G/HD/SD-SDI & Dolby E /Dolby Digital Decoder expansion card

RM-E1X Dolby* E Decoder expansion card

RM-E1B Dolby* E Decoder expansion card

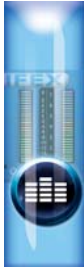

RM-2S4 Reference Monitor, 2 LED meters & 4 stereo channel inputs

RM-2S10 Reference Monitor, 2 LED meters & 10 stereo channel inputs

Introduction



Fig 1-1: RM-2S4 Reference Monitor Front Panel



Fig 1-2: RM-2S10 Reference Monitor Front Panel

The RM-2S4 and RM-2S10 are 1U rack-mount units offering quality loudspeaker monitoring and accurate, high-resolution metering of up to four (RM-2S4) or twenty (RM-2S10 both analogue and digital) stereo audio sources and more with the addition of optional expansion cards. Sources may be in any mixture of analogue and AES/EBU digital formats, with sample rates up to 192kHz accepted.

Sources (and additional Banks of Sources, if fitted) are selected via a front panel rotary encoder, with clear LED indication of the current selection. On the RM-2S10, the Source LEDs also act as signal present indicators. A pair of line-level audio outputs, configurable as analogue or AES/EBU digital, follow the selected source at either a fixed level or one mirroring the loudspeaker volume.

The level of the chosen source is displayed on a pair of bright, multicoloured 53-segment bargraph meters, with a choice of seven accurately modelled scales/responses to suit different applications and local preferences. A separate phase meter indicates channel correlation or phase error conditions. On the rear panel, open-collector alarm outputs provide hardware indication of sustained underlevel, overlevel, phase errors and digital source lock.

Six illuminated pushbuttons provide access to a range of audio 'modifiers' – instant dimming of the volume, individual muting of each audio channel, stereo-to-mono conversion, phase inversion and Middle+Side transcoding. On the rear panel, logic-level inputs allow direct remote access to the DIM and MUTE functions.

The three-way loudspeaker system is fed via a DSP-based active crossover and a trio of highly efficient Class-D amplifiers. Careful attention to driver selection, materials and case design, plus active DSP equalisation, has ensured a flat response and outstanding reproduction from such a shallow unit. A protective limiter prevents damage to the loudspeakers under overload conditions and the front-panel headphone socket automatically mutes the internal loudspeakers when a plug is inserted. A Balance control allows you to alter the stereo imaging of the left and right channels.



1 REFERENCE MONITORS RM-2S4 & RM-2S10

A further five-band parametric equaliser can be accessed for room-equalisation purposes via Sonifex Sci Windows-based remote control software. Source selection, status monitoring and unit ID functions, plus firmware updates to add extra functionality, are all accessible remotely via both USB and RS232 connections in conjunction with Sonifex Sci software. The open control protocol also allows operation with terminal programs or customised applications.

An optional addition to the RM-2S4 and RM-2S10 is an SDI video input expansion card, allowing a single AES group embedded within a 3G, HD or SD-SDI signal to be de-embedded and monitored, (RM-HD1).

Both RM-2S4 and RM-2S10 units operate from global mains voltages (85-264V AC, 47-63Hz) without adjustment.

System Block Diagram

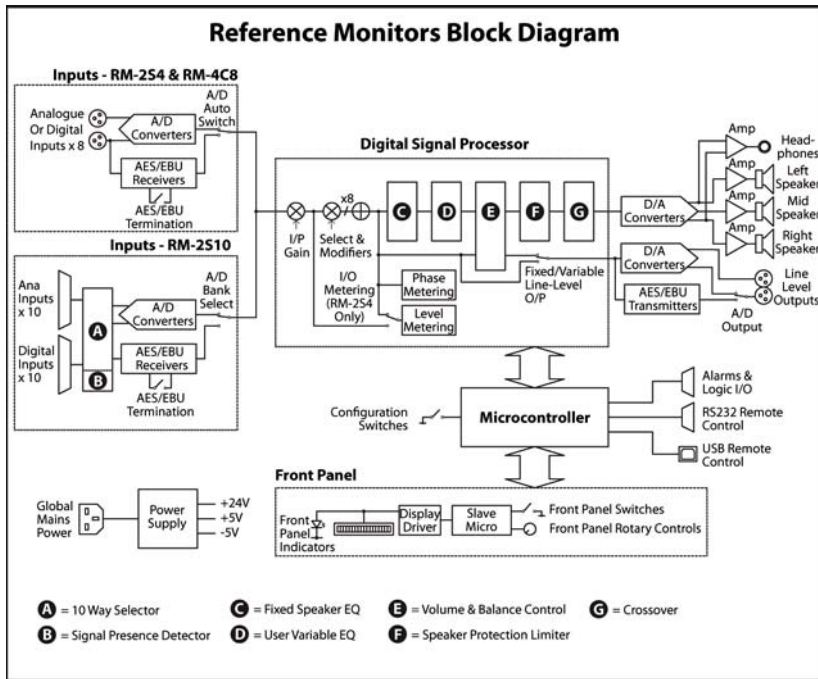

Fig 1-3: Reference Monitor Block Diagram

Front Panel Indicators & Controls



Fig 1-4: RM-2S4 Front Panel Controls



Fig 1-5: RM-2S10 Front Panel Controls

Power LED

The POWER LED illuminates whilst internal power is present within the unit. If this indicator is not on, the most likely reason is simply the absence of mains power, but under fault conditions it may also indicate a ruptured mains fuse or a problem with the internal power supply module.

Rotary Source Selector



Fig 1-6: RM-2S4 Source Selector



Fig 1-7: RM-2S10 Source Selector

The rotary Source selector determines which of the four (RM-2S4) or ten (RM-2S10) stereo audio inputs in the currently selected Bank is routed to the loudspeakers and metering. Turning the selector anticlockwise increments the Source number and vice versa, with the currently selected Source being indicated by illumination of the corresponding Source LED. The currently selected Source can also be changed by the remote control ports (see the relevant sections of this manual), & such changes will also be reflected by the Source LEDs. The Source selector is an endless rotary encoder; further rotation will be ignored once the lowest/highest Source has been selected. If the currently selected Bank contains fewer



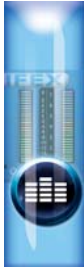

than four (RM-2S4) or ten (RM-2S10) Sources, it will not be possible to select unimplemented Sources.

When mains power is removed, the currently selected Source is stored in non-volatile memory and recalled instantly once power is restored.

Auto-Selection of Inputs

As standard, the RM-2S4 has auto-selection of the inputs, i.e. whichever analogue or digital signal is connected to the input will be used. There is also an option (in the serial settings) for the RM-2S10 to have auto-selection of its separate ten analogue inputs in Bank ANA and ten digital inputs in Bank DIG. For users with a smaller number of mixed analogue and digital sources, the auto-selection allows the unit to switch automatically between the analogue and digital banks according to what is connected.

For the RM-2S10, with auto-selection enabled, both the Bank ANA and Bank DIG LEDs are illuminated (expansion banks can still be selected as normal, if fitted). If the current source selection points to a valid digital input then the digital input will be selected. If it does not, the similarly numbered analogue source will be used. If both are present then the digital input takes precedence (hence auto-selection is only useful for a maximum of ten sources). The analogue and digital presence indications are combined (ORed) and displayed simultaneously.

Bank Selector

Pressing the Source selector knob inwards steps sequentially through all available input Banks (groups of stereo inputs). Each press flashes the selected Bank LED and moves the selected Bank onwards by one step. Once the last available Bank is selected, a further press returns the selection to the first available Bank. The currently selected Bank is indicated by illumination of the corresponding Bank LED.

The currently selected Bank may also be changed via the remote control ports (see the appropriate sections of this manual), and such changes will also be reflected by the Bank LEDs.

On the RM-2S4, BANK A corresponds to the four autoselecting (analogue or digital) stereo inputs found on the rear panel, and further Banks become available with the addition of optional expansion cards.

On the RM-2S10, separate Banks are provided for analogue (BANK ANA) and digital (BANK DIG) sources – a total of twenty stereo sources may be attached if both Banks are fully utilised. Further Banks become available with the addition of optional expansion cards. It is not possible to select Banks which are not fitted.

When mains power is removed, the currently selected Bank is stored in non-volatile memory and recalled instantly once power is restored.

To monitor SDI audio data, an RM-HD1 card has to be fitted. Each SDI signal carries 16 channels of embedded audio divided into four groups. To monitor this audio using an RM-2S10 or RM-2S4 fitted with an RM-HD1 card, select each channel pair using the Source and Bank controls as per the table below:

Bank	Source	Sdi Channel Monitored	SDI Audio Channel Group
EXT A	1	1 + 2	1
	2	3 + 4	
	3	5 + 6	2
	4	7 + 8	
EXT B	1	9 + 10	3
	2	11 + 12	
	3	13 + 14	4
	4	15 + 16	



The lock indicator is used to display the channel active bits in the control packet. If either of the channel active bits are set for the current selection then the lock indicator is set on. For HD-SDI, control packets must be transmitted, but with SD-SDI, control packets are optional. So in the case where no control packet is found but audio data is available, then the unit assumes that all channels are active on the currently selected group and the lock indicator is set on.

Source Presence Indicators (RM-2S10 only)

On the RM-2S10, the presence of active audio on a Source input is indicated by green illumination of the corresponding Source LED. The currently selected Source is indicated by yellow illumination.

This feature may optionally be disabled through the use of the remote control OPT command (see the appropriate section of this manual).

Main Meters

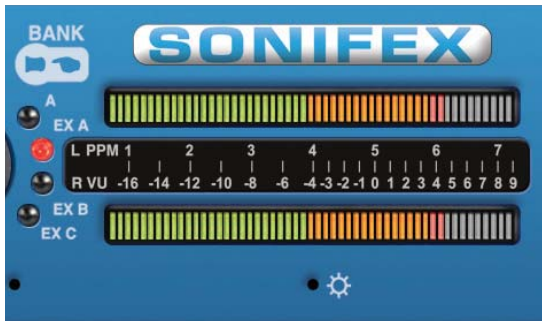

Fig 1-8: RM-2S4 & RM-2S10 Meters

The main meters are twin 53-segment, multicoloured LED bargraphs, displaying the currently selected stereo audio source. The upper meter displays the left channel and the lower meter the right channel.

1 REFERENCE MONITORS RM-2S4 & RM-2S10



REFERENCE MONITORS RM-2S4 & RM-2S10

By default, the meters reflect exactly what is being heard from the loudspeakers including any front panel signal modifiers that are active, i.e. they are “output” meters. For example, if Middle+Side processing is active (see the appropriate section of this manual), the upper meter will display the Middle signal and the lower meter will display the Side. If the CUT modifier is used to mute an input channel, the corresponding meter will display no signal. If preferred, the meters may be made to behave as “input” meters, i.e. not affected by front panel signal modifiers, through the use of the remote control OPT command (see the appropriate section of this manual).

Several different characteristics are available for the meters to suit different applications and regional preferences. The active meter characteristic is selected by the settings of DIPSwitches 8, 9 and 10 on DIPSwitch Block 1 (found on the underside of the unit), according to the following table.

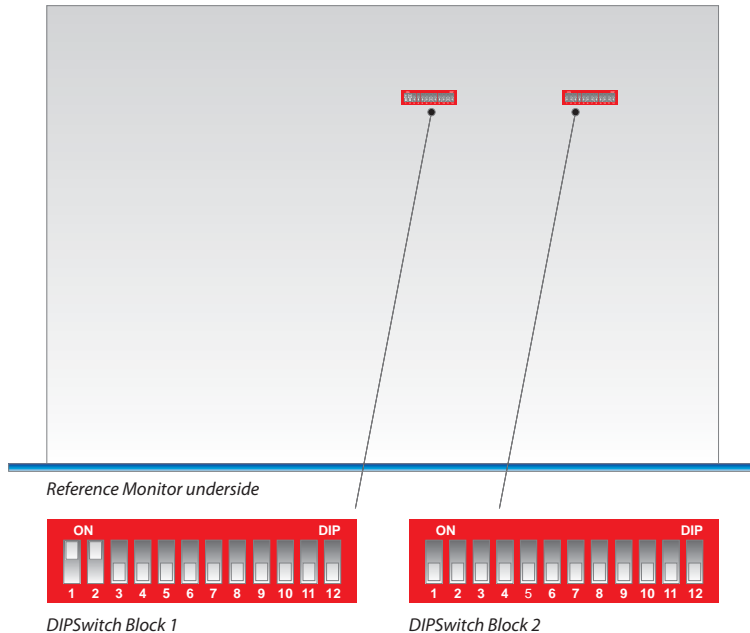

Fig 1-9: RM-2S4 & RM-2S10 DIPSwitch Settings

Note that power should be removed from the unit while making changes to the configuration switches and reapplied once the changes are complete.



Meter Characteristic	Scale Range*	0dBFS Reference	Amber Section Starts at*	Red Section Starts at*	SW8	SW9	SW10	SW11*
Dual PPM + VU	-13 to +13dBu	+18dBu	0dBu	+8dBu	OFF	OFF	OFF	OFF
BBC PPM or EBU PPM**	-13 to +13dBu	+18dBu	0dBu	+8dBu	ON	OFF	OFF	OFF
Nordic PPM	-40 to +12dBu	+18dBu	0dBu	+6dBu	OFF	ON	OFF	OFF
AES Digital PPM	-52 to 0dBFS	+18dBu	-3dBFS	0dBFS	ON	ON	OFF	OFF
DIN PPM	-54 to +5dBu	+18dBu	0dBu	+4dBu	OFF	OFF	ON	OFF
Standard VU	-24 to +3VU	+18dBu	-4VU	0VU	ON	OFF	ON	OFF
Extended VU	-59 to +15VU	+18dBu	-4VU	0VU	OFF	ON	ON	OFF
German PPM	-54 to +15dBu	#+15dBu	-54dBu	+7dBu	ON	ON	ON	OFF

*SW11 is not currently used to select metering settings, but will be used in future versions. Ensure that the switch is set to off.

* With 0dB of input gain selected. # With 0dB input gain (SW6 and SW7 off)

** May be BBC or EBU PPM depending on the choice of scale plate.

Meter Labelling

Each meter characteristic possesses different scaling, range and ballistics according to the relevant British or international standards and self-adhesive scales for each of the characteristics are supplied with the unit.

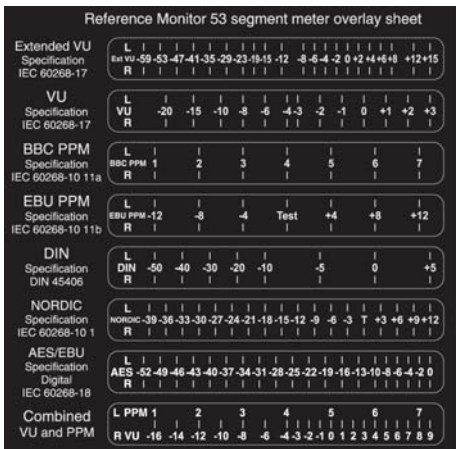

Fig 1-10: Meter Labelling Options

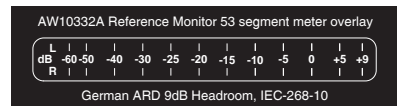

Fig 1-10a: German PPM Labelling Options

1 REFERENCE MONITORS RM-2S4 & RM-2S10

Once the desired meter characteristic has been chosen, proper scale labelling may be ensured by removing the appropriate scale from the backing paper and applying it to the recess provided between the two meters.

Brightness Control

The brightness of the bargraph meters and all other front panel indicators may be adjusted to suit user preference or to match similar units nearby.

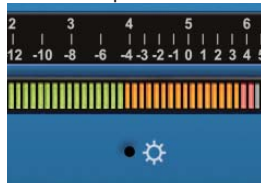
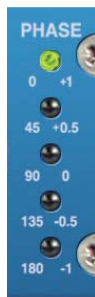

Fig 1-11: Brightness Control

A miniature flat-bladed screwdriver inserted into the hole next to the BRIGHTNESS symbol should be turned clockwise to increase the brightness or anti-clockwise to decrease it.

PHASE Meter



The five-segment LED phase meter indicates the average phase correlation between the left and right channels of the currently selected stereo audio source. It is labelled in both degrees of phase shift and amount of correlation. The phase meter is an "output" meter, reflecting exactly what is being heard from the loudspeakers including any front panel signal modifiers that are active.

A monophonic signal fed to both channels of the selected Source will have a correlation of 1.0, while inverting one such channel – making it perfectly out of phase – gives a correlation of -1.0. True stereo signals will produce a fluctuating phase correlation.

Fig 1-12: Phase Meter Display

An interesting situation arises when only one channel of a stereo source is fed with signal. If the unused channel is perfectly silent (as is possible in the case of a digital source) then the phase correlation will average 0.0, but a small degree of crosstalk between the used and unused channels (as is likely in the case of analogue sources) will allow the signal to self-correlate and the meter will display an average correlation nearer 1.0.

BALANCE Control

The balance control is a centre-detented rotary potentiometer allowing adjustment of the relative balance between the left and right loudspeakers. The control characteristic maintains a constant overall power from the loudspeakers. Turning the



Fig 1-13: Balance Control

balance control fully to the left increases the volume of the left-hand loudspeaker by 6dB and attenuates the right by 6dB, and vice-versa.

LEVEL Control

The LEVEL, or volume, control is a rotary potentiometer allowing volume adjustment of the internal loudspeaker system, the headphone output and optionally the line level outputs (see Line Level Audio Outputs on page 17). A usable control range of 36dB is provided, and with the volume control in the fully anti-clockwise position the signal is completely muted.

High input signal levels and/or high volume settings may result in activation of the loudspeaker protection limiter (refer to the Limiter section of this manual).

Headphone Output

The front panel headphone output is a ¼" (6.35mm) stereo jack socket capable of delivering over 80mW into 32Ω - 600Ω professional headphones at full volume. Higher impedance headphones may be used at reduced levels. Lower impedance headphones should not be used.

Inserting a plug into the headphone socket automatically mutes the internal loudspeakers.

STATUS LED Indicators

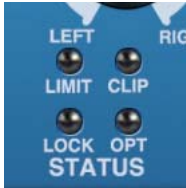

Fig 1-14: Status LEDs

LIMIT indicator

The LIMIT indicator illuminates to show that the loudspeaker protection limiter has been activated. This happens in response to excessive volume levels, which are a product of the input signal level and the setting of the volume control, being requested from the unit and is necessary to prevent permanent damage to the loudspeakers.

The protection limiter is a fast-attack, slow-release type. Brief flashes of the LIMIT indicator on signal peaks are not cause for concern, but significant illumination indicates that the signal is being compressed and that reproduction may be compromised. In those circumstances the setting of the volume control should be reduced.

CLIP indicator

The CLIP indicator illuminates when the signal level of the currently selected source (taking into account any input gain applied – refer to the Inputs section of this manual) has either exceeded or come within 0.5dB of that at which hard clipping occurs.

Analogue input signals will cause clipping if they exceed the maximum acceptable input level (+18dBu with no additional input gain, reducing by 6dB for every 6dB of input gain





applied). The only solution is to reduce the input level and/or the amount of input gain being applied; allowing clipping to persist will irreversibly degrade the audio performance.

The digital audio inputs of the RM-2S4 cannot in themselves clip unless extra input gain has been applied, but signal peaks may come within 0.5dB of maximum if the input signal has undergone aggressive processing at an earlier stage, and the CLIP indicator will respond to this.

LOCK indicator

The LOCK indicator illuminates when a valid digital audio signal is present on the currently selected source input. It will not illuminate if the currently selected Source input is an analogue signal, or if a digital audio signal is applied which has a sample rate outside the acceptable range of the unit, contains invalid/non-audio data or is too weak for the receiver to lock on to.

OPT indicator

The OPT indicator is reserved for future use.

Audio Modifiers



Fig 1-15: RM-2S4 & RM-2S10 Modifier Switches

The audio modifiers are controlled using the 6 white illuminated buttons on the front panel. Each of the modifiers is operated via an illuminated pushbutton switch, with each press of the button toggling the modifier from on to off or vice-versa.

When using the audio modifiers in combination, it is necessary to consider the order in which they are applied since that will affect the results.

The modifiers are applied in the following order (first > last):

Phase invert > Mono > S+D > Dim > Cut L/R

When mains power is removed, the status of the audio modifiers is stored in non-volatile memory and recalled instantly once power is restored.

DIM Audio Modifier

When on, the DIM button is illuminated and the loudspeaker volume level is reduced by 10dB.

The DIM modifier may also be activated by an external signal applied to the rear panel remote control port and the DIM button illuminates when such an external signal is active.

The DIM modifier, unlike the other modifiers, has no effect on the meter readings since it is treated simply as a volume adjustment.

Audio Delay Control (RM-HD1 only)

The DIM audio modifier has a secondary function which is used to add variable delay to the audio coming from the SDI audio de-embedder expansion card (RM-HD1). Delay settings are set through the SCi software. To turn the audio delay on, hold down the DIM button for

approximately two seconds and the button will flash periodically to show that this control is active. To turn the audio delay off, simply perform the same procedure. The DIM audio modifier affects the audio as normal. Before this function can be used, it must first be enabled through the SCi software in the system screen.

CUT L & CUT R Audio Modifiers

When on, the CUT L and CUT buttons are illuminated and the corresponding channel of the selected audio source is muted.

The CUT L and CUT R modifiers may also be simultaneously activated by an external signal applied to the rear panel remote control port. Both CUT buttons will illuminate when such an external signal is active.

The CUT modifiers will affect the loudspeaker audio, line-level audio outputs, phase meter reading and also, by default, the main meter readings (refer to the Main Meters section of this manual).

Speaker Cut Control

The CUT L audio modifier has a secondary function which is used to mute the speakers and is similar to the SPEAKER MUTE remote input pin. To use the speaker cut control, hold down the CUT L button for approximately two seconds and the button will flash periodically to show that this control is active. To turn the speaker cut off simply perform the same procedure. Audio is still present at the headphone and line outputs and the front panel modifiers affect this audio as normal. Before this function can be used, it must first be enabled through the SCi software in the system screen.

Line Output Cut Control

The CUT R audio modifier has a secondary function which is used to mute the line outputs. To turn the line output cut control on, hold down the CUT R button for approximately two seconds and the button will flash periodically to show that this control is active. To turn the speaker cut off simply perform the same procedure. Audio is still present at the headphone and speakers and the front panel modifiers affect this audio as normal. Before this function can be used, it must first be enabled through the SCi software in the system screen.

MONO Audio Modifier

When on, the MONO button is illuminated and the left and right channels of the currently selected stereo audio source are summed into a monophonic signal prior to further processing and reproduction. Scaling is such that a stereo signal measuring 0dBu on both channels will generate a mono signal measuring 0dBu on both channels.

The MONO modifier will affect the loudspeaker audio, line-level audio outputs, phase meter reading and also, by default, the main meter readings (refer to the Main Meters section of this manual).

PHASE INVERT Audio Modifier

When on, the PHASE INVERT button is illuminated and the right channel of the currently selected stereo audio Source is inverted (phase shifted by 180 degrees) prior to further processing and reproduction.



1 REFERENCE MONITORS RM-2S4 & RM-2S10



The PHASE INVERT modifier will affect the loudspeaker audio, line-level audio outputs, phase meter reading and also, by default, the main meter readings (refer to the Main Meters section of this manual).

Being able to invert the polarity of one channel of the monitoring is very useful. For example, sometimes being able to put the speakers deliberately out of phase is useful to identify the presence of a phase error elsewhere in the signal chain. When trying to match the levels of two channels, such as when aligning a stereo pair, being able to invert one channel and then sum to mono (to produce a cancellation null) makes very fast and easy work of an otherwise fiddly process.

MIDDLE + SIDE (M+S) Audio Modifier

When on, the M+S button is illuminated and the left and right channels of the currently selected stereo audio Source are converted to/from a Middle+Side (also known as Sum+Difference) signal prior to further processing and reproduction. An input signal in standard Left+Right (L+R) format will be encoded into M+S format before metering and reproduction, while an input signal in M+S format will be decoded to L+R. The two processes are identical.

The M+S modifier will affect the loudspeaker audio, line-level audio outputs, phase meter reading and also, by default, the main meter readings (refer to the Main Meters section of this manual).

Rear Panel Connections & Operation



Fig 1-16: Reference Monitor RM-2S4 Rear



Fig 1-17: Reference Monitor RM-2S10 Rear

Mains Power

Power is applied via a standard three-pin IEC male socket. Mains voltages between 85V and 264V AC and frequencies between 47 and 63Hz are accepted without adjustment. A 2A, 5 x 20mm SB fuse is used. The Earth pin MUST be connected to ensure safety.

Wordclock Termination (block 2 DIP switch 10)

This terminates the internal wordclock on RM-2S4 and 4C8 units and prevents false clocks or ringing which can cause invalid output signal or noise. This switch should be set to off if a RM-HD1 or HDE1 expansion card is fitted.

Digital Input Termination

Switchable termination is provided to allow the RM-2S4 & RM-2S10 inputs to be bridged across an existing AES/EBU connection without double-termination, but this should only be attempted with the terminating equipment mounted adjacent to the RM-2S4 or RM-2S10 and with connections kept as short as possible.

It is strongly recommended that the digital input termination is set to ON at all times. Failure to do so may result in unreliable reception of digital input signals and/or crosstalk between sources.

Input Gain Adjustment

For both analogue and digital sources the default input gain is zero, i.e. an input of 0dBu results in a reading of 0dBu on the meters. However, to accommodate lower level sources it is possible to introduce extra global input gain in 6dB steps. This gain applies to all inputs and is controlled by the settings of switches 6 and 7 on Block 1 of the configuration switches (found on the underside of the unit), according to the following table. Power should be removed from the unit while making changes to the configuration switches and reapplied once the changes are complete.

Input Gain	Maximum Signal Level (Analogue Sources)	Maximum Signal Level (Digital Sources)	SW6	SW7
0dB	+18dBu	0dBFS	OFF	OFF
+6dB	+12dBu	-6dBFS	ON	OFF
+12dB	+6dBu	-12dBFS	OFF	ON
+18dB	0dBu	-18dBFS	ON	ON

Note that the application of extra input gain reduces the maximum signal level permitted before signal clipping occurs. The front panel CLIP indicator illuminates at the onset of clipping, with extended illumination indicating that the input gain should be reduced and/or the input signal levels attenuated.

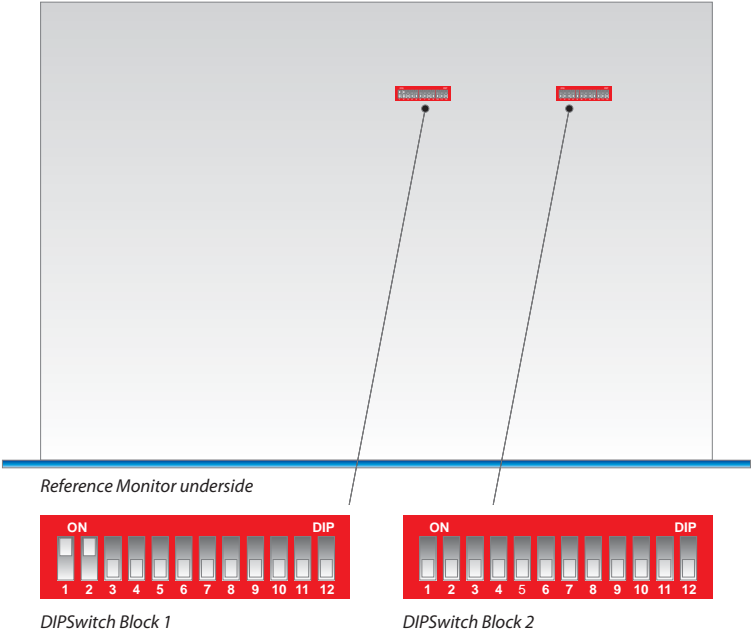

Fig 1-18: RM-2S4 & RM-2S10 DIPswitch Settings





Audio Inputs (RM-2S4)

Three-pin female XLR connectors are provided for the connection of up to four stereo audio sources. Together, these four stereo sources comprise BANK A. The pin assignments are as follows:

Pin 1: Ground

Pin 2: In-phase signal (“hot”)

Pin 3: Out-of-phase signal (“cold”)

Unbalanced signals may also be used by linking pins 1 and 3 and applying the unbalanced signal to pin 2.

Each of the four source inputs accepts either a pair of analogue line-level signals (using both input XLRs) or a single AES/EBU digital signal (attach to the left-hand XLR of the pair and leave the right-hand XLR unconnected). The RM-2S4 automatically detects digital input signals and seamlessly presents them for selection in exactly the same way as analogue ones; the inputs may therefore be any mixture of analogue and digital sources. A full-scale digital input signal (0dBFS) corresponds to the maximum analogue input signal level of +18dBu (with no extra input gain applied).

110 ohm input termination for the AES/EBU digital inputs is controlled by the settings of switches 1, 2, 11 and 12 on Block 2 of the configuration switches, as follows:

SW1: When set to ON, digital input 1 is terminated with 110Ω.

SW2: When set to ON, digital input 2 is terminated with 110Ω.

SW11: When set to ON, digital input 3 is terminated with 110Ω.

SW12: When set to ON, digital input 4 is terminated with 110Ω.

Audio Inputs (RM-2S10)

Three 25-pin female D-type connectors are provided for the simultaneous connection of up to ten stereo analogue (BANK ANA) and ten stereo AES/EBU digital (BANK DIG) audio sources. The pin assignments are as follows:

Pin No.	Function (BANK DIG 1-10)	Function (BANK ANA 1-5)	Function (BANK ANA 6-10)
1	AES/EBU Input 1+	Analogue Input 1L+	Analogue Input 6L+
14	AES/EBU Input 1-	Analogue Input 1L-	Analogue Input 6L-
2	Ground	Ground	Ground
15	AES/EBU Input 2-	Analogue Input 1R-	Analogue Input 6R-
3	AES/EBU Input 2+	Analogue Input 1R+	Analogue Input 6R+
16	AES/EBU Input 3+	Analogue Input 2L+	Analogue Input 7L+
4	AES/EBU Input 3-	Analogue Input 2L-	Analogue Input 7L-
17	Ground	Ground	Ground
5	AES/EBU Input 4-	Analogue Input 2R-	Analogue Input 7R-
18	AES/EBU Input 4+	Analogue Input 2R+	Analogue Input 7R+



6	AES/EBU Input 5+	Analogue Input 3L+	Analogue Input 8L+
19	AES/EBU Input 5-	Analogue Input 3L-	Analogue Input 8L-
7	Ground	Ground	Ground
20	AES/EBU Input 6-	Analogue Input 3R-	Analogue Input 8R-
8	AES/EBU Input 6+	Analogue Input 3R+	Analogue Input 8R+
21	AES/EBU Input 7+	Analogue Input 4L+	Analogue Input 9L+
9	AES/EBU Input 7-	Analogue Input 4L-	Analogue Input 9L-
22	Ground	Ground	Ground
10	AES/EBU Input 8-	Analogue Input 4R-	Analogue Input 9R-
23	AES/EBU Input 8+	Analogue Input 4R+	Analogue Input 9R+
11	AES/EBU Input 9+	Analogue Input 5L+	Analogue Input 10L+
24	AES/EBU Input 9-	Analogue Input 5L-	Analogue Input 10L-
12	Ground	Ground	Ground
25	AES/EBU Input 10-	Analogue Input 5R-	Analogue Input 10R-
13	AES/EBU Input 10+	Analogue Input 5R+	Analogue Input 10R+



Unbalanced signals may also be used by linking the out-of-phase (-) signal pin to Ground and applying the unbalanced signal to the in-phase (+) signal pin.

A full-scale digital input signal (0dBFS) corresponds to the maximum analogue input signal level of +18dBu (with no extra input gain applied).

110 ohm input termination for the AES/EBU digital inputs is on the RM-2S10 controlled by the settings of switches 1 to 10 on the Block 2 of the configuration switches (see Fig 1-18: The RM-2S4 & RM-2S10 DIPswitches), as follows:

- SW1: When set to ON, digital input 10 is terminated with 110 Ω.
- SW2: When set to ON, digital input 9 is terminated with 110 Ω.
- SW3: When set to ON, digital input 8 is terminated with 110 Ω.
- SW4: When set to ON, digital input 7 is terminated with 110 Ω.
- SW5: When set to ON, digital input 6 is terminated with 110 Ω.
- SW6: When set to ON, digital input 5 is terminated with 110 Ω.
- SW7: When set to ON, digital input 4 is terminated with 110 Ω.
- SW8: When set to ON, digital input 3 is terminated with 110 Ω.
- SW9: When set to ON, digital input 2 is terminated with 110 Ω.
- SW10: When set to ON, digital input 1 is terminated with 110 Ω.

Line Level Audio Outputs

A pair of three-pin male XLR connectors provides a stereo line-level audio output carrying the selected audio Source signal. The XLR pin assignments are as follows:

- Pin 1: Ground
- Pin 2: In-phase signal ("hot")
- Pin 3: Out-of-phase signal ("cold")



The signals may be unbalanced without loss of level by linking pins 1 and 3 and taking the unbalanced signal from pin 2.

The line-level outputs may be configured either as analogue (using both output XLRs) or AES/EBU digital (attach to the left-hand XLR of the pair and leave the right-hand XLR unconnected). The selection of format is determined by the setting of switches 1-4 in Block 1 of the configuration switches (see Fig 1-18), according to the following table. Switch 5 in the same block determines whether the line-level outputs are fixed in level or proportional in level to the setting of the volume control. Power should be removed from the unit while making changes to the configuration switches and reapplied once the changes are complete.

Output Format	Output Level	SW1 & 2	SW3 & 4	SW5
Analogue	Variable	Both ON	Both OFF	OFF
Analogue	Fixed	Both ON	Both OFF	ON
AES/EBU Digital	Variable	Both OFF	Both ON	OFF
AES/EBU Digital	Fixed	Both OFF	Both ON	ON

The line-level output signals are always affected by the setting of the front-panel audio modifiers, with one exception - DIM only affects the line-level outputs when Variable output level is selected.

Expansion Port

An internal expansion card (RM-HD1 or RM-HDE1) may be fitted to the RM-2S4 or RM-2S10 to increase the number of inputs and/or add to the available functions. Please note DIP switch 10 should be set to off for RM-2S4 units please refer to the documentation accompanying the expansion card for further details.

Remote Inputs and Outputs

A 15-way male D-type connector carries four open-collector status outputs, four logic-level control inputs plus power and data lines for future expansion. The pin assignments are as follows:

Pin No.	I/O	Function
1	O	Audio underlevel/fail alarm – latching open collector
9	I	MUTE input – pull low to activate
2	O	Audio overlevel alarm – latching open collector
10	I	DIM input – pull low to activate
3	O	Sustained phase error alarm – latching open collector
11	I	Alarm Reset – pull low to activate
4	O	AES/EBU lock output – non-latching open collector
12	I	SPEAKER MUTE - pull low to activate
5	I	Volume control voltage from 0-5volts**
13	I	Balance control voltage from 0-5volts**
6	O	Fused power for desktop remote control panel 24V
14	-	Ground
7	O	Serial data transmit for future use
15	I	Serial data receive*
8	O	Serial clock for future use

* Link this pin to pin 6 via a 10kohm resistor to enable remote volume balance, (this must also be enabled in the Sci system screen).

** Please note both remote volume and balance are enabled by pin 15 so both must be set to a voltage level.

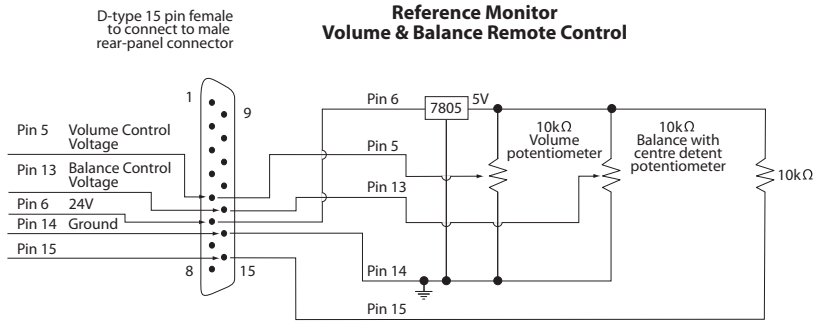

For this to operate, tick the "Enable Remote Volume" option in the Sci Reference Monitor Control Software.

Open-collector outputs are low (conducting) during alarm conditions. When an alarm occurs they begin conducting and, with the exception of the AES/EBU lock output, remain in that condition until the Alarm Reset input is asserted. Open-collector outputs are rated at 50mA and 30V.

The Audio Overlevel alarm is triggered if either channel of the currently selected input source exceeds +12dBu for longer than 5 seconds.

The Audio Underlevel alarm is triggered if either channel of the currently selected input source remains below -20dBu for longer than 20 seconds.

The Sustained Phase Error alarm is triggered if the phase difference between the two channels of the currently selected input source remains consistently above 90 degrees for longer than 5 seconds.

The AES/EBU Lock output is a real-time (non-latching) status output which becomes active if a valid AES/EBU signal is detected on the currently selected Source input. By default, the open-collector output is low (conducting) when a valid AES signal is detected, but this behaviour may be reversed using the serial remote control LCK: command.

The active-low control inputs all have internal pull-ups. Equipment driving these inputs need sink only 1mA and block 5V.

The MUTE input mutes the loudspeakers, headphone output and line outputs while held low. The front panel CUT L and CUT R buttons illuminate to indicate that MUTE is asserted.



1 REFERENCE MONITORS RM-2S4 & RM-2S10



The SPEAKER MUTE input mutes the speakers in the Reference Monitor. Audio is still present at the headphone and line outputs and the front panel modifiers affect this audio as normally.

Note: this function is operational from firmware version V1.116 and onwards.

The DIM input reduces the loudspeaker/headphone level by 10dB while held low (for example, whilst an external talkback system is active). The front panel DIM button illuminates to indicate that DIM is asserted.

Asserting the Alarm Reset input by pulling it low resets any active Alarm outputs to their untriggered states and allows them to monitor for new alarm conditions.

RS232 Remote Control

A 9-way female D-type connector carries a standard RS232 interface via which advanced configuration options may be set and many functions may be remotely controlled. The pin assignments are as follows:

Pin 2: Data transmit

Pin 3: Data receive

Pin 5: Ground

All other pins are unused.

The RM-2S4 and RM-2S10 will interface directly with personal computer serial ports at standard RS232 signal levels using a straight-through cable. The data format is 19200 baud with 8 data bits, even parity and 1 stop bit. XON/XOFF flow control is used when necessary.

Sonifex SCi software, when installed on a suitable PC, provides straightforward graphical access to all remote control and configuration options via both RS232 and USB interfaces.

Alternatively, commands may be issued from any text-based terminal program (e.g. Hyperterminal) or custom software may be developed for specific requirements.

USB Remote Control

A Type B USB socket carries a standard Universal Serial Bus interface via which advanced configuration options may be set and many functions may be remotely controlled.

The RM-2S4 and RM-2S10 will interface directly with personal computer USB ports using a standard USB cable. On first connection, the user will be prompted to install the necessary USB driver (supplied), following which the USB connection behaves as a "virtual serial port" with identical data format and command protocol as the RS232 remote control interface.

Sonifex SCi software, when installed on a suitable PC, provides straightforward graphical access to all remote control and configuration options via both RS232 and USB interfaces.

Alternatively, commands may be issued from any text-based terminal program (e.g. Hyperterminal) or custom software may be developed for specific requirements – see the section of this manual on the serial command protocol for further information.

Sonifex SCi software is available free of charge from the sonifex website - www.sonifex.co.uk



Technical Specification RM-2S4 & RM-2S10

Inputs

Audio Inputs (RM-2S4):	4 x stereo analogue or AES/EBU digital (autoselecting)
Audio Inputs (RM-2S10):	10 x stereo analogue, plus 10 x stereo AES/EBU digital
Max Level (0dB Input Gain):	+18dBu (analogue)/0dBFS (digital)
CMRR:	>60dB typical
Input Impedance:	20kΩ (analogue) 110 Ω (digital with termination switchable)
AES/EBU Sample Rate:	32 to 192kHz, converted internally to 48kHz
Input Gain:	0, +6, +12 or +18dB digital gain (switchable)
Selection:	Front panel rotary control with indicator LEDs

Line Level Outputs

Audio Outputs:	1 x stereo analogue or AES/EBU digital (switchable)
Gain re Selected Input:	Unity or variable, following volume control (switchable)
Maximum Output Level:	+18dBu (analogue)/0dBFS (digital)
Output Impedance:	<50 Ω (analogue)/110 Ω (digital)
AES/EBU Sample Rate:	48kHz
Distortion:	<0.02% (1kHz, +8dBu output)
Noise:	-84dB RMS, unity gain ref +8dBu output
Frequency Response:	20Hz-20kHz +0/-0.5dB
Crosstalk:	Analogue I/O, ref 0dBu
1kHz Input:	<-90dB
10kHz input:	<-85dB

Audio Modifiers

Modifier Selection:	Illuminated front panel pushbuttons
DIM:	Reduces speaker audio level by 10dB
CUT L & CUT R:	Mutes left/right speaker audio
MONO:	Combines left and right audio inputs
PHASE INVERT:	Inverts phase of right audio input
M+S:	Converts stereo input to Middle (sum) and Side (difference) signals



User-Variable Equalisation

Type:	Parametric
Bands:	Five
Centre Frequency:	200Hz to 18kHz
Bandwidth:	0.25 to 2 octaves
Boost/Cut:	± 12 dB
Programming:	Via USB/serial control port

Amplifier/Loudspeakers

Configuration:	Three-way with stereo mid/high-frequency drivers & mono low-frequency driver
Power Output:	2 x 5W (HF) + 20W (LF) with protective limiter
Crossover:	500Hz (3rd order Butterworth)
Distortion (HF Outputs):	< 0.05% (1kHz, 3W output)
Distortion (LF Output):	< 0.05% (100Hz, 6W output)
Noise:	More than 80dB below full output
Volume:	Mute to full volume via front panel rotary control
Balance Trim:	± 6 dB via front panel rotary control.
Peak Acoustic Level:	102dB SPL @ 2ft

Level Metering

Number:	2 x 53-segment tri-colour LED bargraphs	
Characteristics:	Selectable by switch from:	
	1. Dual BBC PPM + standard VU	
	2. BBC PPM	IEC60268-10 11a
	3. EBU PPM	IEC60268-10 11b
	4. Nordic PPM	IEC60268-10 1
	5. AES/EBU digital PPM	IEC60268-18
	6. DIN PPM	DIN45406
	7. Standard VU	IEC60268-17
	8. Extended VU	IEC60268-17
Ballistics:	According to selected characteristic	
Line-Up Level:	According to selected characteristic	



Phase Metering

Type: 5-segment, indication at 0, 45, 90, 135 and 180 degrees

Remote Control

USB: Slave device, 19200 baud

Serial: RS232, 19200 baud, 3-wire connection

Alarm Outputs:

1. Audio underlevel/fail (latching)
2. Audio overlevel (latching)
3. Sustained phase error (latching)
4. AES/EBU input unlock (non-latching)

Open-collector outputs rated at 30V, 50mA maximum
Output low/conducting in normal condition (no alarm)

Control Inputs:

1. Mute audio
2. Dim audio
3. Alarm reset

Pull-to-ground to activate inputs

Status Indicators

LIMIT: Indicates loudspeaker protection limiter is active.

CLIP: Indicates internal digital clipping due to overlevel.

LOCK: Indicates lock achieved on selected digital input(s).

OPT: For future use.

Connectors

Audio Inputs (RM-2S4): 8 x XLR 3-pin female (balanced, may be unbalanced)

Audio Inputs (RM-2S10): 3 x D-type 25-pin female (balanced, may be unbalanced)

Audio Outputs: XLR 3-pin male (balanced, may be unbalanced)

Headphones: 1/4" (6.35mm) A-gauge 3-pole stereo jack socket

USB: Type B socket

Serial: D-sub 9-pin female

Remote I/O: D-sub 15-pin male

Mains Input: Filtered 3-pin IEC male, continuously rated 85 - 264VAC, 47 - 63Hz, fused 2A, 60W peak, 30W average

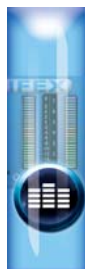
**DIP Switch Settings (Underneath The Unit, See Fig 1-17)****Block 1 (RM-2S4 & RM-2S10)**

SW1	Audio Output	Analogue ON	Digital OFF
SW2	Audio Output	Analogue ON	Digital OFF
SW3	Audio Output	Digital ON	Analogue OFF
SW4	Audio Output	Digital ON	Analogue OFF
SW5	Output Level	Fixed ON	Variable OFF
SW6	Input Gain Matrix		
SW7	Input Gain Matrix		
SW8	Meter Ballistics & Scaling Matrix		
SW9	Meter Ballistics & Scaling Matrix		
SW10	Meter Ballistics & Scaling Matrix		
SW11	Meter Ballistics & Scaling Matrix		
SW12	Firmware Update	Force Bootload ON	Normal Operation OFF

Block 2 (RM-2S4)

SW1	Digital Input Termination	Input 1 110Ω ON	Unterminated OFF
SW2	Digital Input Termination	Input 2 110Ω ON	Unterminated OFF
SW3-SW9	Unused		
SW10	Enable Wordclock Termination (disable for units fitted with HD1 and HDE1 cards)		
SW11	Digital Input Termination	Input 3 110Ω ON	Unterminated OFF
SW12	Digital Input Termination	Input 4 110Ω ON	Unterminated OFF

Block 2 (RM-2S10)

SW1	Digital Input Termination	Input 10 110Ω ON	Unterminated OFF
SW2	Digital Input Termination	Input 9 110Ω ON	Unterminated OFF
SW3	Digital Input Termination	Input 8 110Ω ON	Unterminated OFF
SW4	Digital Input Termination	Input 7 110Ω ON	Unterminated OFF
SW5	Digital Input Termination	Input 6 110Ω ON	Unterminated OFF
SW6	Digital Input Termination	Input 5 110Ω ON	Unterminated OFF
SW7	Digital Input Termination	Input 4 110Ω ON	Unterminated OFF
SW8	Digital Input Termination	Input 3 110Ω ON	Unterminated OFF



SW9	Digital Input Termination	Input 2 110Ω ON	Unterminated OFF
SW10	Digital Input Termination	Input 1 110Ω ON	Unterminated OFF
SW11	Unused		Set to OFF
SW12	Unused		Set to OFF

Equipment Type

RM-2S4	Reference Monitor, 2 LED meters, 4 stereo channel inputs
RM-2S10	Reference Monitor, 2 LED meters, 10 stereo channel inputs

Physical Specification

Dimensions (Raw):	48cm (W) x 30.5cm (D) x 4.4cm (H) (1U) 19" (W) x 12" (D*) x 1.7" (H) (1U)
Dimensions (Boxed):	55cm (W) x 43cm (D) x 18cm (H) 21.7" (W) x 16.9" (D*) x 7.1" (H) (1U)
Weight:	Nett: 4.5kg Gross: 5.9kg Nett: 10lb Gross: 13lb

Options

RM-HD1	3G/HD/SD-SDI expansion card
--------	-----------------------------



2 REFERENCE MONITORS RM-4C8

RM-4C8 Reference Monitor, 4 LED meters, 8 channel inputs & dual selectors

Introduction



Fig 2-1: RM-4C8 Reference Monitor Front Panel

The RM-4C8 is a 1U rack-mount unit offering quality loudspeaker monitoring and accurate, high-resolution metering of up to eight mono audio sources and more with the addition of an optional expansion card. Sources may be in any mixture of analogue and AES/EBU digital formats, with sample rates up to 192kHz accepted.

The Sources for both left- and right-hand loudspeakers (and additional Banks of Sources, if available) are individually selected via a pair of front panel rotary encoders, with clear LED indication of the current selections. A pair of line-level audio outputs, configurable as analogue or AES/EBU digital, follow the selected sources at either a fixed level or one mirroring the loudspeaker volume.

The levels of the selected bank of four sources are simultaneously displayed on a quartet of bright, multicoloured 26-segment bargraph meters, with a choice of seven accurately modelled scales/responses to suit different applications and local preferences. A separate phase meter indicates channel correlation or phase error conditions between the two selected sources. On the rear panel, open-collector alarm outputs provide hardware indication of sustained underlevel, overlevel, phase errors and digital source lock.

Six illuminated pushbuttons provide access to a range of audio 'modifiers' – instant dimming of the volume, muting of each audio channel, stereo-to-mono conversion, phase inversion and Middle+Side transcoding. On the rear panel, logic-level inputs allow direct remote access to the DIM and MUTE functions.

The three-way loudspeaker system is fed via a DSP-based active crossover and a trio of highly efficient Class-D amplifiers. Careful attention to driver selection, materials and case design, plus active DSP equalisation, has ensured a flat response and outstanding reproduction from such a shallow unit. A protective limiter prevents damage to the loudspeakers under overload conditions and the front-panel headphone socket automatically mutes the internal loudspeakers when a plug is inserted. A Balance control allows you to alter the stereo image, or Pan, of the two selected sources.

A further five-band parametric equaliser can be accessed for room-equalisation purposes via Sonifex SCi Windows-based remote control software. Source selection, status monitoring and unit ID functions, plus firmware updates to add extra functionality, are all accessible remotely via both USB and RS232 connections in conjunction with Sonifex SCi software. The open control protocol also allows operation with terminal programs or customised applications.

Optional additions to the RM-4C8 include SDI video input expansion cards and Dolby Decoding cards, allowing an audio AES group embedded within a 3G, HD or SD-SDI signal to be de-embedded and monitored, either with Dolby E and Dolby Digital decoding (RM-HDE1) or without (RM-HD1). Or alternatively with Dolby E and Dolby Digital decoding from an AES source (RM-E1X from XLRs) or RM-E1B (from BNCs).

For information on operation of the RM-4C8 with the RM-HDE1, RM-E1X and RM-E1B expansion cards, please refer to sections 3 and 4.

The RM-4C8 operates from global mains voltages (85-264V AC, 47-63Hz) without adjustment.

System Block Diagram

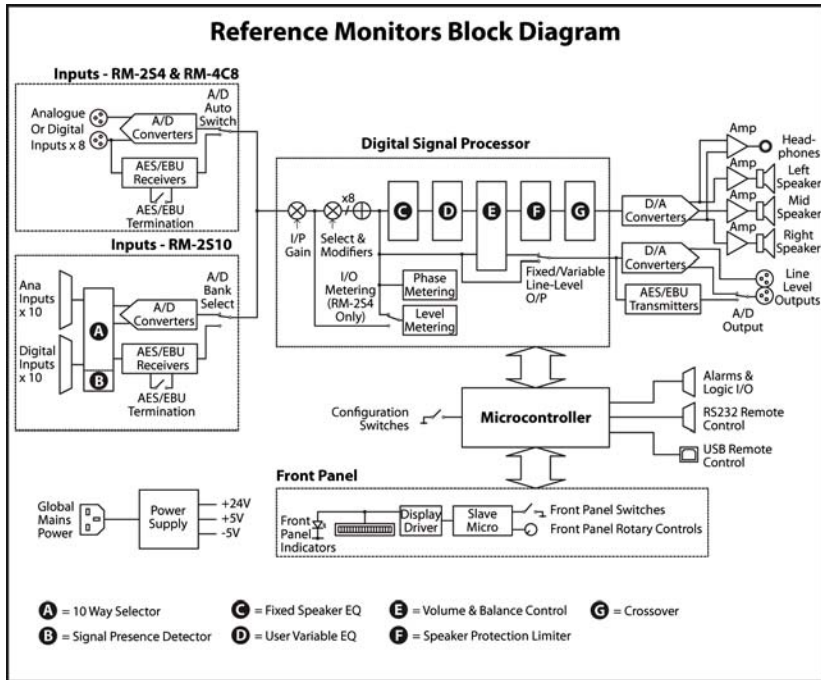

Fig 2-2: Reference Monitor Block Diagram



Front Panel Indicators & Controls



Fig 2-3: RM-4C8 Front Panel Controls

Power LED

The POWER LED illuminates whilst internal power is present within the unit. If this indicator is not on, the most likely reason is simply the absence of mains power, but under fault conditions it may also indicate a ruptured mains fuse or a problem with the internal power supply module.

Rotary Source Selectors



Fig 2-4: RM-4C8 Rotary Source Selectors

The two rotary Source selectors determine which of the four audio inputs in the currently selected Bank is routed to each loudspeaker. To increment the Source number, the left-hand selector should be turned anticlockwise and the right-hand selector clockwise; rotation in the opposite direction decrements the Source number. The currently selected Sources are indicated by illumination of the corresponding Source LEDs.

The currently selected Sources may also be changed via the remote control ports, using the Sonifex Sci software and such changes will also be reflected by the Source LEDs.

The Source selectors are endless rotary encoders; further rotation once the lowest/highest Source has been selected will be ignored. If the currently selected Bank contains fewer than four Sources, it will not be possible to select unimplemented Sources.

When mains power is removed, the currently selected Sources are stored in non-volatile memory and recalled instantly once power is restored.

Auto-Selection of Inputs

As standard, the RM-4C8 has auto-selection of the inputs, i.e. whichever analogue or digital signal is connected to the input will be used.

Bank Selector

Pressing the left-hand Source selector knob inwards steps sequentially through all available input Banks (groups of four inputs). Each press moves the selected Bank onwards by one step; once the last available Bank is selected, a further press returns the selection to the first available Bank. The currently selected Bank is indicated by illumination of the corresponding Bank LED. The currently selected Bank may also be changed via the remote control ports (see the appropriate sections of this manual), and such changes will also be reflected by the Bank LEDs.

As standard, the RM-4C8 possesses two Banks, A and B. Both comprise four monophonic Sources, each of which may be a mono analogue signal, part of a stereo analogue signal, part of a stereo AES/EBU digital signal or any combination thereof. Attaching a valid AES/EBU digital signal automatically assigns its two channels to a pair of Sources. Further Banks become available with the addition of optional expansion cards. It is not possible to select Banks which are not fitted.

When mains power is removed, the currently selected Bank is stored in non-volatile memory and recalled instantly once power is restored.

When the RM-HD1 expansion card is fitted to the RM-4C8 the banks EX A, EX B, EX C and EX D become available for selection. These are used to select which audio group is de-embedded and monitored from the SDI input connected to the unit.

Bank	Embedded Audio Group
EX A	1
EX B	2
EX C	3
EX D	4

Channel pair 1 is displayed on meters 1 and 2, while channel pair 2 is displayed on meters 3 and 4. The two rotary Source selectors work as normal and determine which of the channels are routed to each loudspeaker. For example, to listen to channels 1 and 3 of audio group 1, then set the bank selection to EX A, the left source selector to 1 and the right source selector to 3.

The two lock indicators on the front panel below the right source selector are used to display the channel active bits contained within the control packet of the embedded audio data. If channels 1 or 2 are active then the left lock indicator is set on, if channels 3 or 4 are active then the right lock indicator is set on. For 3G/HD-SDI, control packets must be transmitted, but with SD-SDI, control packets are optional. So in the case where no control packet is found but audio data is available, then the unit assumes that all channels are active on the currently selected group and both lock indicators are set on.





Main Meters



The main meters are quad 26-segment, multicoloured LED bargraphs, displaying the four Sources in the currently selected Bank.

The meters behave as “input” meters, i.e. they are not affected by front panel signal Modifiers such as Middle+Side or Cut.

Several different characteristics are available for the meters to suit different applications and regional preferences. The active meter characteristic is selected by

Fig 2-5: RM-4C8 Meters

the settings of DIPSwitches 8, 9 and 10 on DIPSwitch Block 1 (found on the underside of the unit), according to the following table.

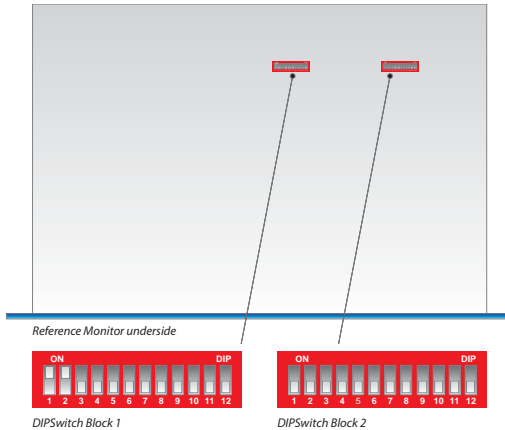

Fig 2-6: RM-4C8 DIPSwitch Settings

Note that power should be removed from the unit while making changes to the configuration switches and reapplied once the changes are complete.

Meter Characteristic	Scale Range*	0dBFS Reference	Amber Section Starts at*	Red Section Starts at*	SW8	SW9	SW10	SW11*
Dual PPM + VU	-13 to +13dBu	+18dBu	0dBu	+8dBu	OFF	OFF	OFF	OFF
BBC PPM or EBU PPM**	-13 to +13dBu	+18dBu	0dBu	+8dBu	ON	OFF	OFF	OFF
Nordic PPM	-40 to +12dBu	+18dBu	0dBu	+6dBu	OFF	ON	OFF	OFF
AES Digital PPM	-52 to 0dBFS	+18dBu	-3dBFS	0dBFS	ON	ON	OFF	OFF

DIN PPM	-54 to +5dBu	+18dBu	0dBu	+4dBu	OFF	OFF	ON	OFF
Standard VU	-24 to +3VU	+18dBu	-4VU	0VU	ON	OFF	ON	OFF
Extended VU	-59 to +15VU	+18dBu	-4VU	0VU	OFF	ON	ON	OFF
German PPM	-54 to +15dBu	*+15dBu	-54dBu	+7dBu	ON	ON	ON	OFF

*SW11 is not currently used to select metering settings, but will be used in future versions. Ensure that the switch is set to off.

* With 0dB of input gain selected.

** May be BBC or EBU PPM depending on choice of scale plate.

With 0dB input gain (SW6 and SW7 off)

Meter Labelling

Each meter characteristic possesses different scaling, range and ballistics according to the relevant British or International standards and self-adhesive scales for each of the characteristics are supplied with the unit.

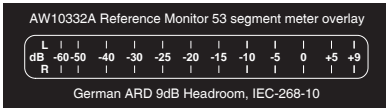

Fig 2-7: German PPM Labelling Options

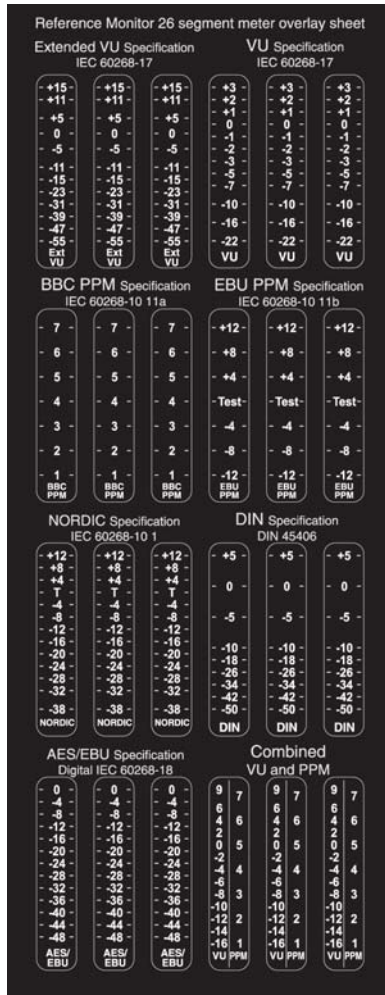

Fig 2-7a: Meter Labelling Options



Once the desired meter characteristic has been chosen, proper scale labelling may be ensured by removing the appropriate scales from the backing paper and applying them to the recesses provided between the meters.

Brightness Control

The brightness of the bargraph meters and all other front panel indicators may be adjusted to suit user preference or to match similar units nearby.



Fig 2-8: Brightness Control

A miniature flat-bladed screwdriver inserted into the hole marked BRIGHTNESS should be turned clockwise to increase the brightness or anti-clockwise to decrease.

PHASE Meter

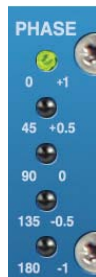

The five-segment LED phase meter indicates the average phase correlation between the two currently selected audio Sources. It is labelled in both degrees of phase shift and amount of correlation. The phase meter is an “output” meter, reflecting exactly what is being heard from the loudspeakers including any front panel signal Modifiers that are active.

If both selected Sources carry the same signal, a correlation of 1.0 will result, while inverting one channel – making it perfectly out of phase – gives a correlation of -1.0. True stereo signals will produce a fluctuating phase correlation.

Fig 2-9: Phase Meter Display

An interesting situation arises when only one of the selected Sources is fed with signal. If the unused channel is perfectly silent (as is possible in the case of a digital source) then the phase correlation will average 0.0, but a small degree of crosstalk between the used and unused channels (as is likely in the case of analogue sources) will allow the signal to self-correlate and the meter will display an average correlation nearer 1.0.



BALANCE Control

The balance control is a centre-detented rotary potentiometer allowing adjustment of the relative balance between the left and right loudspeakers. The control characteristic maintains a constant overall power from the loudspeakers. turning the balance control fully to the left increases the volume of the left-hand loudspeaker by 6dB and attenuates the right by 6dB, and vice-versa.

Fig 2-10: Balance Control

LEVEL Control

The LEVEL, or volume, control is a rotary potentiometer allowing volume adjustment of the internal loudspeaker system, the headphone output and optionally the line level outputs (see Line Level Audio Outputs on page 37). A usable control range of 36dB is provided, and with the volume control in the fully anti-clockwise position the signal is completely muted. High input signal levels and/or high volume settings may result in activation of the loudspeaker protection limiter (refer to the Limiter section of this manual).

Headphone Output

The front panel headphone output is a ¼" (6.35mm) stereo jack socket capable of delivering over 80mW into 32Ω - 600Ω professional headphones at full volume. Higher impedance headphones may be used at reduced levels. Lower impedance headphones should not be used.

Inserting a plug into the headphone socket automatically mutes the internal loudspeakers.

STATUS LED Indicators

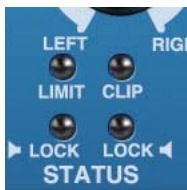

Fig 2-11: Status LEDs

LIMIT indicator

The LIMIT indicator illuminates to show that the loudspeaker protection limiter has been activated. This happens in response to excessive volume levels – which are a product of input signal level and the setting of the volume control – being requested from the unit and is necessary to prevent permanent damage to the loudspeakers.

The protection limiter is a fast-attack, slow-release type. Brief flashes of the LIMIT indicator on signal peaks are not cause for concern, but significant illumination indicates that the signal is being compressed and that reproduction may be compromised. In those circumstances the setting of the volume control should be reduced.

CLIP indicator

The CLIP indicator illuminates when the signal level of either currently selected Source (taking into account any input gain applied – refer to the Inputs section of this manual) has exceeded or come within 0.5dB of that at which hard clipping occurs.

Analogue input signals will cause clipping if they exceed the maximum acceptable input level (+18dBu with no additional input gain, reducing by 6dB for every 6dB of input gain applied). The only solution is to reduce the input level and/or the amount of input gain being applied; allowing clipping to persist will irreversibly degrade the audio performance.

2 REFERENCE MONITORS RM-4C8

The digital audio inputs of the RM-4C8 cannot in themselves clip unless extra input gain has been applied, but signal peaks may come within 0.5dB of maximum if the input signal has undergone aggressive processing at an earlier stage, and the CLIP indicator will respond to this.

LOCK L and LOCK R indicators

The LOCK indicators illuminate when a valid digital audio signal is present on the corresponding currently selected Source input. They will not illuminate if the currently selected Source input is an analogue signal, or if a digital audio signal is applied which has a sample rate outside the acceptable range of the unit, contains invalid/non-audio data or is too weak for the receiver to lock on to.

Audio Modifiers



Fig 2-12: RM-4C8 Modifier Switches

The audio modifiers are controlled using the 6 white illuminated buttons on the front panel. Each of the modifiers is operated via an illuminated pushbutton switch, with each press of the button toggling the modifier from on to off or vice-versa.

When using the audio modifiers in combination, it is necessary to consider the order in which they are applied since that will affect the results.

The modifiers are applied in the following order (first > last):

Phase invert > Mono > S+D > Dim > Cut L/R

When mains power is removed, the status of the audio modifiers is stored in non-volatile memory and recalled instantly once power is restored.

DIM Audio Modifier

When on, the button is illuminated and the loudspeaker volume level is reduced by 10dB. The DIM modifier may also be activated by an external signal applied to the rear panel remote control port. The DIM button will illuminate when such an external signal is active.

Audio Delay Control (RM-HD1 only)

The DIM audio modifier has a secondary function which is used to add variable delay to the audio coming from the SDI audio de-embedder expansion card (RM-HD1). Delay settings are set through the SCi software. To turn the audio delay on, hold down the DIM button for approximately two seconds and the button will flash periodically to show that this control is active. To turn the audio delay off, simply perform the same procedure. The DIM audio modifier affects the audio as normal. Before this function can be used, it must first be enabled through the SCi software in the system screen.

CUT L & CUT R Audio Modifiers

When on, the button is illuminated and the corresponding loudspeaker channel is muted. The CUT L and CUT R modifiers may also be simultaneously activated by an external signal applied to the rear panel remote control port. Both CUT buttons will illuminate when such

an external signal is active.

The CUT modifiers will affect the loudspeaker audio, line-level audio outputs and phase meter reading.

Speaker Cut Control

The CUT L audio modifier has a secondary function which is used to mute the speakers and is similar to the SPEAKER MUTE remote input pin. To use the speaker cut control, hold down the CUT L button for approximately two seconds and the button will flash periodically to show that this control is active. To turn the speaker cut off simply perform the same procedure. Audio is still present at the headphone and line outputs and the front panel modifiers affect this audio as normal. Before this function can be used, it must first be enabled through the SCi software in the system screen.

Line Output Cut Control

The CUT R audio modifier has a secondary function which is used to mute the line outputs. To turn the line output cut control on, hold down the CUT R button for approximately two seconds and the button will flash periodically to show that this control is active. To turn the speaker cut off simply perform the same procedure. Audio is still present at the headphone and speakers and the front panel modifiers affect this audio as normal. Before this function can be used, it must first be enabled through the SCi software in the system screen.

MONO Audio Modifier

When on, the button is illuminated and the two currently selected audio Source signals are summed into a monophonic signal prior to further processing and reproduction. Scaling is such that two selected Sources each measuring 0dBu will deliver a mono signal measuring 0dBu to both channels.

The MONO modifier will affect the loudspeaker audio, line-level audio outputs and phase meter reading.

PHASE INVERT Audio Modifier

When on, the button is illuminated and the selected right-hand Source signal is inverted (phase shifted by 180 degrees) prior to further processing and reproduction.

The PHASE INVERT modifier will affect the loudspeaker audio, line-level audio outputs and phase meter reading.

MIDDLE + SIDE (M+S) Audio Modifier

When on, the button is illuminated and the currently selected Source signals are converted to/from Middle+Side (also known as Sum+Difference) format prior to further processing and reproduction. Input signals in standard Left+Right (L+R) format will be encoded into M+S format before reproduction, while input signals in M+S format will be decoded to L+R – the two processes are identical.

The M+S modifier will affect the loudspeaker audio, line-level audio outputs and phase meter reading.



2 REFERENCE MONITORS RM-4C8



Rear Panel Connections & Operation



Fig 2-13: RM-4C8 Rear

Mains Power

Power is applied to the unit via a standard three-pin IEC male socket. Mains voltages between 85 and 264V AC and frequencies between 47 and 63Hz are accepted without adjustment.

The Earth pin MUST be connected to ensure safety.

Wordclock Termination (block 2 DIP switch 10)

This terminates the internal wordclock on RM-2S4 and 4C8 units and prevents false clocks or ringing which can cause invalid output signal or noise. This switch should be set to off if a RM-HD1 or HDE1 expansion card is fitted.

Digital Input Termination

Switchable termination is provided to allow the RM-4C8 inputs to be bridged across an existing AES/EBU connection without double-termination, but this should only be attempted with the terminating equipment mounted adjacent to the RM-4C8 and with connections kept as short as possible.

It is strongly recommended that the digital input termination is set to ON at all times. Failure to do so may result in unreliable reception of digital input signals and/or crosstalk between Sources.

110 ohm input termination for the AES/EBU digital inputs is controlled by the settings of switches 1, 2, 11 and 12 on Block 2 of the configuration switches (see Fig 2-6: The RM-4C8 DIPSwitch Settings), as follows:

- SW1: When set to ON, digital input A1/2 is terminated with 110Ω.
- SW2: When set to ON, digital input A3/4 is terminated with 110Ω.
- SW11: When set to ON, digital input B1/2 is terminated with 110Ω.
- SW12: When set to ON, digital input B3/4 is terminated with 110Ω.

Input Gain Adjustment

For both analogue and digital Sources the default input gain is zero, i.e. an input of 0dBu results in a reading of 0dBu on the meters. However, to accommodate lower level sources it is possible to introduce extra global input gain in 6dB steps. This gain applies to all inputs and is controlled by the settings of switches 6 and 7 on the right-hand block of configuration switches (found on the underside of the unit), according to the following table. Power should be removed from the unit while making changes to the configuration switches and reapplied once the changes are complete.

Input Gain	Maximum Signal Level (Analogue Sources)	Maximum Signal Level (Digital Sources)	SW6	SW7
0dB	+18dBu	0dBFS	OFF	OFF
+6dB	+12dBu	-6dBFS	ON	OFF
+12dB	+6dBu	-12dBFS	OFF	ON
+18dB	0dBu	-18dBFS	ON	ON

Note that the application of extra input gain reduces the maximum signal level permitted before signal clipping occurs. The front panel CLIP indicator illuminates at the onset of clipping, with extended illumination indicating that the input gain should be reduced and/or the input signal levels attenuated.

Audio Inputs

Three-pin female XLR connectors are provided for the connection of up to eight balanced audio Sources in two Banks (A and B) of four. The pin assignments are as follows:

- Pin 1: Ground
- Pin 2: In-phase signal ("hot")
- Pin 3: Out-of-phase signal ("cold")

Unbalanced signals may also be used by linking pins 1 and 3 and applying the unbalanced signal to pin 2.

Each Source input accepts an analogue line-level signal, which may be a complete monophonic signal or one half of a stereo pair. Two of the four XLRs in each Bank also accept AES/EBU digital signals, the two channels of which are automatically routed to a pair of Source channels as per the connector labelling.

The RM-4C8 automatically detects digital input signals and seamlessly presents them for selection in exactly the same way as analogue ones; the inputs may therefore be any mixture of analogue and digital Sources. A full-scale digital input signal (0dBFS) corresponds to the maximum analogue input signal level of +18dBu (with no extra input gain applied).

Line Level Audio Outputs

A pair of three-pin male XLR connectors provides a stereo line-level audio output carrying the selected audio Source signals. The XLR pin assignments are as follows:

- Pin 1: Ground
- Pin 2: In-phase signal ("hot")
- Pin 3: Out-of-phase signal ("cold")

The signals may be unbalanced without loss of level by linking pins 1 and 3 and taking the unbalanced signal from pin 2.

The line-level outputs may be configured either as analogue (using both output XLRs) or AES/EBU digital (attach to the left-hand XLR of the pair and leave the right-hand XLR unconnected). The selection of format is determined by the setting of switches 1-4 in Block 1 of the configuration switches (see Fig 2-6), according to the following table. Switch 5 in the same block determines whether the line-level outputs are fixed in level or proportional in level to the setting of the volume control. Power should be removed from the unit while making changes to the configuration switches and reapplied once the changes are complete.



2 REFERENCE MONITORS RM-4C8



Output Format	Output Level	SW1 & 2	SW3 & 4	SW5
Analogue	Variable	Both ON	Both OFF	OFF
Analogue	Fixed	Both ON	Both OFF	ON
AES/EBU Digital	Variable	Both OFF	Both ON	OFF
AES/EBU Digital	Fixed	Both OFF	Both ON	ON

The line-level output signals are always affected by the setting of the front-panel audio Modifiers, with one exception - DIM only affects the line-level outputs when Variable output level is selected.

Expansion Port

An internal expansion card (RM-HD1 or RM-HDE1) may be fitted to the RM-4C8 to increase the number of inputs and/or add to the available functions (Please note DIP switch 10 must be set to off if an expansion card is fitted). Refer to Section 3 of this handbook for further details.

Remote Inputs and Outputs

A 15-way male D-type connector carries four open-collector status outputs, four logic-level control inputs plus power and data lines for future use. The pin assignments are as follows:

Pin No.	I/O	Function
1	O	Audio underlevel/fail alarm – latching open collector
9	I	MUTE input – pull low to activate
2	O	Audio overlevel alarm – latching open collector
10	I	DIM input – pull low to activate
3	O	Sustained phase error alarm – latching open collector
11	I	Alarm Reset – pull low to activate
4	O	AES/EBU lock output – non-latching open collector
12	I	SPEAKER MUTE - pull low to activate
5	I	Volume control voltage for future use
13	I	Balance control voltage for future use
6	O	Fused power for desktop remote control panel 24V
14	-	Ground
7	O	Serial data transmit for future use
15	I	Serial data receive for future use
8	O	Serial clock for future use

See page 19 for a schematic showing remote Volume and Balance controls.

Open-collector outputs are low (conducting) during alarm conditions. When an alarm occurs they begin conducting and, with the exception of the AES/EBU lock output, remain in that condition until the Alarm Reset input is asserted. Open-collector outputs are rated at 50mA and 30V.

The Audio Overlevel alarm is triggered if either currently selected input Source exceeds +12dBu for longer than 5 seconds.

The Audio Underlevel alarm is triggered if either currently selected input Source remains below -20dBu for longer than 20 seconds.

The Sustained Phase Error alarm is triggered if the phase difference between the two currently selected input Sources remains consistently above 90 degrees for longer than 5 seconds.

The AES/EBU Lock output is a real-time (non-latching) status output which becomes active if a valid AES/EBU signal is detected. By default, the open-collector output is low (conducting) when a valid AES signal is detected on either of the currently selected Source inputs. However, the polarity of the output may be reversed and/or a requirement imposed that a valid signal be present on both currently selected Source inputs using the serial remote control LCK: command.

The active-low control inputs all have internal pull-ups. Equipment driving these inputs need sink only 1mA and block 5V.

The MUTE input mutes the loudspeakers, headphone output and line outputs while held low. The front panel CUT L and CUT R buttons illuminate to indicate that MUTE is asserted.

The SPEAKER MUTE input mutes the speakers in the Reference Monitor. Audio is still present at the headphone and line outputs and the front panel modifiers affect this audio as normally.

Note: this function is operational from firmware version V1.116 and onwards.

The DIM input reduces the loudspeaker/headphone level by 10dB while held low (for example, whilst an external talkback system is active). The front panel DIM button illuminates to indicate that DIM is asserted.

Asserting the Alarm Reset input by pulling it low resets any active Alarm outputs to their untriggered states and allows them to monitor for new alarm conditions.

RS232 Remote Control

A 9-way female D-type connector carries a standard RS232 interface via which advanced configuration options may be set and many functions may be remotely controlled. The pin assignments are as follows:

Pin 2: Data transmit

Pin 3: Data receive

Pin 5: Ground

All other pins are unused.

The RM-4C8 will interface directly with personal computer serial ports at standard RS232 signal levels using a straight-through cable. The data format is 19200 baud with 8 data bits, even parity and 1 stop bit. XON/XOFF flow control is used when necessary.

Sonifex SCi software, when installed on a suitable PC, provides straightforward graphical access to all remote control and configuration options via both RS232 and USB interfaces. Alternatively, commands may be issued from any text-based terminal program (e.g. Hyperterminal) or custom software may be developed for specific requirements.





USB Remote Control

A Type B USB socket carries a standard Universal Serial Bus interface via which advanced configuration options may be set and many functions may be remotely controlled.

The RM-4C8 will interface directly with personal computer USB ports using a standard USB cable. On first connection, the user will be prompted to install the necessary USB driver (supplied), following which the USB connection behaves as a “virtual serial port” with identical data format and command protocol as the RS232 remote control interface.

Sonifex Sci software, when installed on a suitable PC, provides straightforward graphical access to all remote control and configuration options via both RS232 and USB interfaces. Alternatively, commands may be issued from any text-based terminal program (e.g. Hyperterminal) or custom software may be developed for specific requirements – see the section of this manual on the serial command protocol for further information.

Sonifex Sci software is available free of charge from the sonifex website - www.sonifex.co.uk

Technical Specification RM-4C8

Inputs

Number of Channels:	8 x analogue or AES/EBU digital inputs (autoselecting).
Max Level (0dB Input Gain):	+18dBu (analogue)/0dBFS (digital).
CMRR:	> 60dB typical
Input impedance:	20k Ω (analogue) 110 Ω (digital with termination switchable).
AES/EBU Sample Rate:	32 to 192kHz, converted internally to 48kHz.
Input Gain:	0, +6, +12 or +18dB digital gain (switchable).
Selection:	2 x Front panel rotary controls with indicator LEDs.

Line Level Outputs

Audio Outputs:	1 x stereo analogue or AES/EBU digital (switchable)
Gain re Selected Input:	Unity or variable, following volume control (switchable)
Maximum Output Level:	+18dBu (analogue)/0dBFS (digital)
Output Impedance:	<50 Ω (analogue)/110 Ω (digital)
AES/EBU Sample Rate:	48kHz
Distortion:	<0.02% (1kHz, +8dBu output)
Noise:	-84dB RMS, unity gain ref +8dBu output
Frequency Response:	20Hz-20kHz +0/-0.5dB

Crosstalk:	Analogue I/O, ref 0dBu
1kHz Input:	<-90dB
10kHz input:	<-85dB

Audio Modifiers

Modifier Selection:	Illuminated front panel pushbuttons
DIM:	Reduces speaker audio level by 10dB
CUT L & CUT R:	Mutes left/right speaker audio
MONO:	Combines left and right audio inputs
PHASE INVERT:	Inverts phase of right audio input
M+S:	Converts stereo input to Middle (sum) and Side (difference) signals

User-Variable Equalisation

Type:	Parametric
Bands:	Five
Centre Frequency:	200Hz to 18kHz
Bandwidth:	0.25 to 2 octaves
Boost/Cut:	±12dB
Programming:	Via USB/serial control port

Amplifier/Loudspeakers

Configuration:	Three-way with stereo mid/high-frequency drivers & mono low-frequency driver
Power Output:	2 x 5W (HF) + 20W (LF) with protective limiter
Crossover:	500Hz (3rd order Butterworth)
Distortion (HF Outputs):	< 0.05% (1kHz, 3W output)
Distortion (LF Output):	< 0.05% (100Hz, 6W output)
Noise:	More than 80dB below full output
Volume:	Mute to full volume via front panel rotary control
Balance Trim:	±6dB via front panel rotary control.
Peak Acoustic Level:	102dB SPL @ 2ft

Level Metering

Number:	4 x 26-segment tri-colour LED bargraphs.
---------	--



2 REFERENCE MONITORS RM-4C8



REFERENCE MONITORS RM-4C8

Characteristics:	Selectable by switch from:
	1. Dual BBC PPM + standard VU
	2. BBC PPM IEC60268-10 11a
	3. EBU PPM IEC60268-10 11b
	4. Nordic PPM IEC60268-10 1
	5. AES/EBU digital PPM IEC60268-18
	6. DIN PPM DIN45406
	7. Standard VU IEC60268-17
	8. Extended VU IEC60268-17

Ballistics: According to selected characteristic.

Line-up level: According to selected characteristic.

Phase Metering

Type: 5-segment, indication at 0, 45, 90, 135 and 180 degrees.

Remote Control

USB: Slave device, 19200 baud

Serial: RS232, 19200 baud, 3-wire connection

Alarm Outputs:

1. Audio underlevel/fail (latching)
2. Audio overlevel (latching)
3. Sustained phase error (latching)
4. AES/EBU input unlock (non-latching)

Open-collector outputs rated at 30V, 50mA maximum
Output low/conducting in normal condition (no alarm)

Control Inputs:

1. Mute audio
2. Dim audio
3. Alarm reset

Pull-to-ground to activate inputs

Status Indicators

LIMIT: Indicates loudspeaker protection limiter is active.

CLIP: Indicates internal digital clipping due to overlevel.

LOCK L/R: Indicates lock achieved on selected digital inputs.

Connectors

Audio Inputs: 8 x XLR 3-pin female (balanced, may be unbalanced)

Audio Outputs: XLR 3-pin male (balanced, may be unbalanced)

Headphones:	1/4" (6.35mm) A-gauge 3-pole stereo jack socket
USB:	Type B socket.
Serial:	D-sub 9-pin female.
Remote I/O:	D-sub 15-pin male.
Mains Input:	Filtered 3-pin IEC male, continuously rated 85 - 264VAC, 47 - 63Hz, fused 2A, 60W peak, 30W average

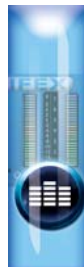

DIP Switch Settings (Underneath The Unit, See Fig 2-6)

Block 1

SW1	Audio Output	Analogue ON	Digital OFF
SW2	Audio Output	Analogue ON	Digital OFF
SW3	Audio Output	Digital ON	Analogue OFF
SW4	Audio Output	Digital ON	Analogue OFF
SW5	Output Level	Fixed ON	Variable OFF
SW6	Input Gain Matrix		
SW7	Input Gain Matrix		
SW8	Meter Ballistics & Scaling Matrix		
SW9	Meter Ballistics & Scaling Matrix		
SW10	Meter Ballistics & Scaling Matrix		
SW11	Meter Ballistics & Scaling Matrix		
SW12	Firmware Update	Force Bootload ON	Normal Operation OFF

Block 2

SW1	Digital Input Termination	Input 1 110Ω ON	Unterminated OFF
SW2	Digital Input Termination	Input 2 110Ω ON	Unterminated OFF
SW3-SW9 Unused			
SW10	Enable Wordclock Termination (disable for units fitted with HD1 and HDE1 cards)		
SW11	Digital Input Termination	Input 3 110Ω ON	Unterminated OFF
SW12	Digital Input Termination	Input 4 110Ω ON	Unterminated OFF

Equipment Type

RM-4C8	Reference Monitor, 4 LED meters, 8 channel inputs & dual selectors
--------	--

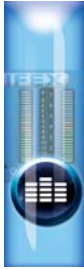

Physical Specification

Dimensions (Raw): 48cm (W) x 30.5cm (D) x 4.4cm (H) (1U)
19" (W) x 12" (D*) x 1.7" (H) (1U)

Dimensions (Boxed): 55cm (W) x 43cm (D) x 18cm (H)
21.7" (W) x 16.9" (D*) x 7.1" (H) (1U)

Weight: Nett: 4.5kg Gross: 5.9kg
 Nett: 10lb Gross: 13lb

Options

RM-HD1 3G/HD/SD-SDI expansion card

RM-HDE1 3G/HD/SD-SDI & Dolby E Decoder expansion card

RM-E1X Dolby E Decoder XLR AES expansion card

RM-E1B Dolby E Decoder BNC AES expansion card

RM-HD1 Reference Monitor 3G/HD/SD-SDI Expansion Card

This expansion board allows the monitoring of embedded non-encoded linear PCM audio channels within an 3G/HD/SD-SDI video signal.

The RM-HD1 card can be used with the RM-2S4, RM-2S10 and RM-4C8 monitors.

The expansion board can extract any selected AES/EBU audio group (4 channels) from the video signal and pass them to the main Reference Monitor unit for monitoring. Any group can be selected and can also be optionally delayed by up to ~300ms by using the Sonifex SCi remote control software. All channels in the selected group can be monitored visually and 2 channels can be selected to be monitored on the speakers (for the RM-2S4 and RM-2S10, stereo pairs are selected; the RM-4C8 allows any 2 channels to be monitored).

The input is auto-sensing for either SD, HD or 3G input formats and the extraction of embedded audio complies with SMPTE-272 (SD) and SMPTE-299 (HD/3G).

The SDI input is equalized, internally re-clocked and re-transmitted to provide a re-clocked output to pass to external equipment such as another reference monitor.



Fig 3-1: RM-HD1 Expansion Card

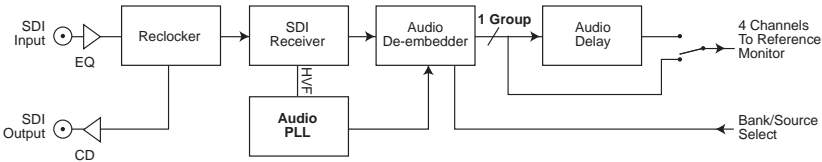

Fig 3-2: RM-HD1 Block Diagram

Maximum Audio Delay Through RM-HD1

Samples	14300						
Milliseconds	297.9						
	NTSC	PAL	720/60p	720/50p	1080/50i	1080/60i	1080/60p
Frames	8.9	7.4	17.9	14.9	7.4	8.9	17.9
Fields	17.9	14.9	17.9	14.9	14.9	17.9	17.9
Lines	4687	4655	13406	11172	8379	10055	20109





Technical Specification For RM-HD1

SDI Specification

SDI Input:	1 x BNC, 3G/HD/SD-SDI
SDI Outputs:	1 x BNC, 3G/HD/SD-SDI, Re-clocked
Impedance:	75Ω
Output Alignment Jitter:	<0.2UI
Output Level:	800mV +/- 10%
Return Loss:	<15dB at 1500MHz
SDI Supported Standards:	270Mbps, SMPTE-259M-C (SD) 1.485 or 1.4835Gbps, SMPTE-292M (HD) 2.97 or 2.967Gbps, SMPTE-424M (3G)
Supported Video Formats:	525/59.94 (SMPTE-125M) 625/50 (ITU-R BT.656) 720p/23.98, 24, 25, 29.97, 30, 50, 59.94, 60 (SMPTE-296M) 1035i/59.94, 60 (SMPTE-260M) 1080i/50, 59.94, 60 (SMPTE-274M) 1080p/23.98, 24, 25, 50, 59.94, 60 (SMPTE-274M) 1080pSF/23.98, 24, 25, 29.97, 30 (RP-211) 1080i/50 (SMPTE-295M) 1080p/50 (SMPTE-295M)
Embedded Audio:	48kHz, synchronous (HD asynchronous) SMPTE-272M-ABC SMPTE-299M

Equipment Type

RM-HD1:	3G/HD/SD-SDI expansion card
---------	-----------------------------

Physical Specification

Dimensions (Raw):	15cm (W) x 11.5cm (D) x 3.1cm (H) 5.9" (W) x 4.5" (D*) x 1.2" (H) (1U)
Dimensions (Boxed):	25cm (W) x 20cm (D) x 10cm (H) 9.8" (W) x 7.9" (D*) x 3.9" (H) (1U)
Weight (RM-HD1):	Nett: 0.13kg Gross: 0.4kg Nett: 0.31lb Gross: 0.9lb

RM-HDE1 Reference Monitor 3G/HD/SD-SDI & Dolby® E Expansion Card

This expansion board allows the monitoring of embedded audio channels within an 3G/HD/SD-SDI video signal. The embedded audio can be either non-encoded linear PCM, Dolby® E or Dolby® Digital. Please note that the RM-HDE1 card is for use with the RM-4C8 unit only.

The expansion board can extract any selected AES/EBU audio group (4 channels) from the video signal and pass them to the main Reference Monitor unit for monitoring. Any group can be selected. All channels in the selected group can be monitored visually and any 2 channels can be selected to be monitored on the speakers. If a Dolby E or Dolby Digital input is detected on the selected channel, the Channels (CHANS) button flashes to indicate that decoding is possible. Pressing the CHANS button displays the Dolby Digital 5.1 or Dolby E 8 channel signal, using the 4 bar-graph meters. Each meter is split into 2 sections, top and bottom, allowing you to monitor all 8 channels coming from the Decoder..

Full Dolby Metadata is available using the SCi remote control software. For a more detailed description of Dolby Decoding operation please refer to the Reference Monitor handbook

The input is auto-sensing for either SD, HD or 3G input formats and the extraction of embedded audio complies with SMPTE-272 (SD) and SMPTE-299 (HD/3G). The SDI input is equalized, internally re-clocked and re-transmitted to provide a re-clocked output to pass to external equipment such as another reference monitor.



Fig 3-3: RM-HDE1 Expansion Card

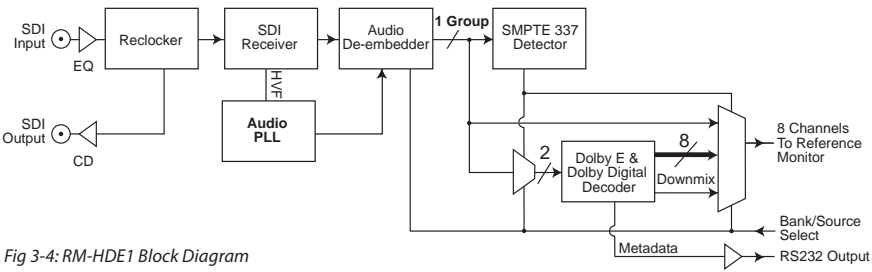

Fig 3-4: RM-HDE1 Block Diagram



REFERENCE MONITORS RM-HD(E)1, RM-E1X & RM-E1B



Technical Specification For RM-HDE1

SDI Specification

SDI Input:	1 x BNC, 3G/HD/SD-SDI
SDI Outputs:	1 x BNC, 3G/HD/SD-SDI, Re-clocked
Impedance:	75Ω
Output Alignment Jitter:	<0.2UI
Output Level:	800mV +/- 10%
Return Loss:	<15dB at 1500MHz
SDI Supported Standards:	270Mbps, SMPTE-259M-C (SD) 1.485 or 1.4835Gbps, SMPTE-292M (HD) 2.97 or 2.967Gbps, SMPTE-424M (3G)
Supported Video Formats:	525/59.94 (SMPTE-125M) 625/50 (ITU-R BT.656) 720p/23.98, 24, 25, 29.97, 30, 50, 59.94, 60 (SMPTE-296M) 1035i/59.94, 60 (SMPTE-260M) 1080i/50, 59.94, 60 (SMPTE-274M) 1080p/23.98, 24, 25, 50, 59.94, 60 (SMPTE-274M) 1080pSF/23.98, 24, 25, 29.97, 30 (RP-211) 1080i/50 (SMPTE-295M) 1080p/50 (SMPTE-295M)
Embedded Audio:	48kHz, synchronous (HD asynchronous) SMPTE-272M-ABC SMPTE-299M

Equipment Type

RM-HDE1:	3G/HD/SD-SDI & Dolby® E expansion card
----------	--

Physical Specification

Dimensions (Raw):	15cm (W) x 11.5cm (D) x 3.1cm (H) 5.9" (W) x 4.5" (D*) x 1.2" (H) (1U)
Dimensions (Boxed):	25cm (W) x 20cm (D) x 10cm (H) 9.8" (W) x 7.9" (D*) x 3.9" (H) (1U)
Weight (RM-HDE1):	Nett: 0.15kg Gross: 0.4kg Nett: 0.31lb Gross: 0.9lb

RM-E1X Dolby E Decoder XLR AES Expansion Card & RM-E1B Dolby E Decoder BNC Expansion Card For RM-4C8

These expansion boards for the Reference Monitor RM-4C8 allow the monitoring of a digital audio stream containing either Linear PCM or Dolby* encoded audio.

The RM-E1X has 2 x XLR inputs to accept AES/EBU level inputs and the RM-E1B has 2 x BNC connectors for S/PDIF level inputs.

Dolby data is decoded and passed to the Reference Monitor as either a stereo down mix or the full complement of individual channels. If the signal is standard Linear PCM, then this audio data is simply passed straight through.

The input is re-transmitted with minimal delay, to allow connection to other equipment.



REFERENCE MONITORS RM-HD(E)1, RM-E1X & RM-E1B

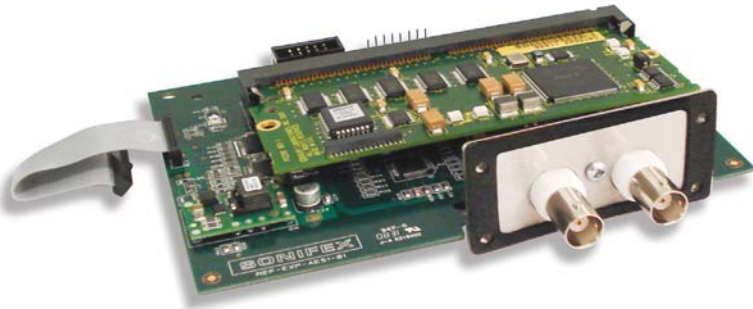

Fig 3-5: RM-E1B Expansion Card

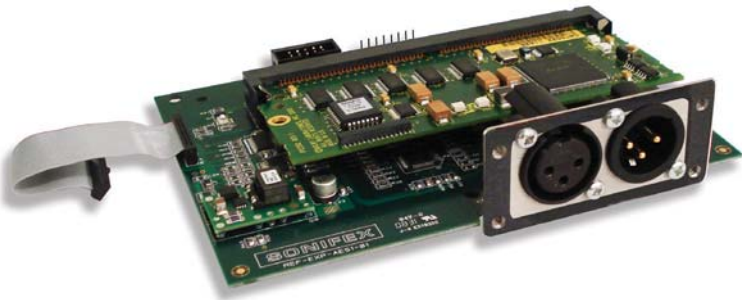

Fig 3-6: RM-E1X Expansion Card

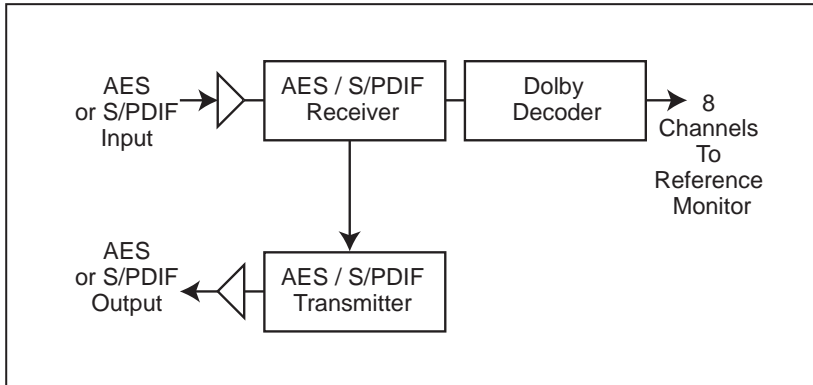

Fig 3-7: RM-E1X/B Block Diagram

Technical Specification For RM-E1X and RM-E1B

AES Input/Output (RM-E1X):	110Ω transformer coupled balanced I/O
S/PDIF Input/Output (RM-E1B):	75Ω transformer coupled unbalanced I/O
Sample Rates:	32 - 48 kHz
Audio Formats:	Linear PCM Dolby E (16, 20 and 24 bit) Dolby Digital (16 and 32 bit)

Connectors

AES Input:	1 x XLR 3 pin socket (RM-E1X)
AES Output:	1 x XLR 3 pin plug (RM-E1X)
S/PDIF Input:	1 x BNC (RM-E1B)
S/PDIF Output:	1 x BNC (RM-E1B)

Fitting An Expansion Card

To install an RM-HD1, RM-HDE1 RM-E1X or RM-E1B expansion card into a Reference Monitor, follow the procedure below.

- 1) Disconnect the Reference Monitor from the mains supply.
- 2) Remove all the lid screws and take off the lid.
- 3) Remove the rear blanking plate (4 x M3 x 6 screws).
- 4) Remove the nylock nut from the main PCB (second one in from the left of the unit when looking from the rear) and fit the 27mm M3 pillar on to the stud.
- 5) Remove the self tapping screw from the plastic mount on the expansion board and remove the plate.
- 6) Place the expansion board plate into the rear of the unit (do not fix it yet as it will need to be loose to aid in the alignment of the expansion board).
- 7) Plug the expansion board trailing cable into the expansion connector on the main board.
- 8) Insert the expansion board into the rear of the unit, putting the BNC or XLR connectors through the loose plate first.
- 9) Once in position, screw the expansion plate to the rear of the unit with the 4 x M3 x 6mm screws removed earlier.
- 10) Fix the expansion board to the plate with the self tap screw into the plastic mount on the board.
- 11) Screw the expansion board to the pillar with the M3 x 6 screw supplied.
- 12) Refit the lid with the 19 off M3 x 8mm countersunk screws. Ensure that all screws are fitted loosely before finally tightening.
- 13) Reconnect your Reference Monitor to the mains supply and check operation.
- 14) Update the Reference Monitor's firmware to the latest version using the Sonifex SCi software. The firmware is downloadable from the Sonifex website, see Reference Monitor SCi Remote Control Software on page 62.

Please note DIP switch 10 should be set to off for RM-2S4 units.



4 REFERENCE MONITOR RM-4C8 WITH RM-HDE1, RM-E1X OR RM-E1B

Reference Monitor RM-4C8 with an RM-E1X, RM-E1B or RM-HDE1 Dolby Decoder Expansion Card



Fig 4-1: Dolby RM-4C8 Front Panel

Operation of The RM-4C8 With The RM-E1X or RM-E1B Fitted

When the RM-4C8 is fitted with an RM-E1X or RM-E1B expansion card, it can be used to decode and monitor Dolby® E or Dolby Digital encoded AES-3 audio streams. These streams are decoded and monitored as either a stereo downmix of the selected program or the full channel complement so that each individual channel can be separately monitored and metered. It can also be used to monitor a standard digital audio input if needed.

The expansion card input, EX A, is selected via the front panel Bank selection control. When selected, the front panel buttons INV and M+S have dual functionality. If normal PCM audio is detected on the input, then these buttons operate normally as INV and M+S illuminated orange. When a Dolby encoded format is detected then their secondary function becomes active and the buttons illuminate green. The secondary functions of the INV and M+S buttons are PROGS (Programs) and CHANS (Channels) respectively and are used to indicate and control monitoring of the multichannel audio.

When Bank EX A is selected, the CHANS button flashes green to indicate that a multichannel format is detected and the downmix is being monitored. When the PROGS button is flashing green, this indicates that a Dolby E format has been detected. If neither button is flashing then no Dolby Encoded stream is detected on the input and the audio is treated as PCM. The modes and the button states are shown in the table below.

Mode	Front Panel Buttons & States	
	∅ INV / PROGS	M+S / CHANS
PCM	Off / Orange	Off / Orange
Dolby Digital Downmix	Off	Flashing Green
Dolby Digital Multichannel Monitoring	Off	Green
Dolby E Downmix	Off / Flashing Green	Flashing Green
Dolby E Multichannel Monitoring	Off / Flashing Green	Green
Dolby E Program Select	Green	Flashing Green

By default, when switching to Bank EX A, if a valid Dolby encoded stream is detected, the unit automatically enters downmix mode.

RM-4C8 WITH RM-HDE1, RM-E1X OR RM-E1B

Operation of The RM-4C8 With The RM-HDE1 Fitted

When the RM-4C8 is fitted with an RM-HDE1 expansion card, it can be used to decode and monitor Dolby E or Dolby Digital encoded data streams embedded within an 3G/HD/SD-SDI video source. These streams are decoded and monitored as either a stereo downmix of the selected program or the full channel compliment, so that each individual channel can be separately monitored and metered. It can also be used to de-embed normal linear PCM as per the RM-HD1.

The four audio groups, EX A, EX B, EX C and EX D are selected via the front panel Bank selection control. These determine which of the four audio groups is to be de-embedded from the SDI video stream. If the selected group contains one or more Dolby encoded audio streams then the unit will enter Dolby mode. This mode works by selecting the active channel pair being monitored within the group. This is performed with the left rotary source selector. If the current selection is one of the channels in channel pair one (1 or 2) then the first channel pair is active. If the current selection is one of the channels within pair two (3 or 4) then the second channel pair is active. The right rotary source selector is ignored for the purposes of channel pair selection.

For example, if the audio group consisted of a Dolby stream in channel pair 1 (inputs 1 & 2) and a normal PCM stream in channel pair 2 (inputs 3 & 4), then selection of either source 1 or 2 with the left rotary source selector will put the unit into Dolby mode and the functionality of the PROGS and CHANS buttons will change accordingly.

When two Dolby streams are contained within a single group, only the downmix from the active channel pair is available for monitoring due to there being only one decoder available within the unit. The other Dolby stream is muted.

Group Audio Configuration		Meter Outputs	
Channel pair 1	Channel pair 2	Meters 1&2	Meters 3&4
PCM	PCM	Channel pair 1	Channel pair 2
Dolby stream	PCM	Downmix	Channel pair 2
PCM	Dolby stream	Channel pair 1	Downmix
Dolby stream	Dolby stream	Downmix or muted	Downmix or muted

Downmix Mode

Downmix mode is indicated by the flashing of the CHANS button and is the default mode when selecting the expansion card input, EX A. The two-channel downmix is provided to allow simple stereo monitoring of multichannel audio. This stereo representation is called Left only/Right only or Lo/Ro and adds the Left and Right surround channels to the Left and Right speaker channels, respectively.

When a Dolby E encoded stream is presented to the input of the expansion card then this will be a downmix of the currently selected program.

In this mode, only the first two meters will be active and the channels can be selectively routed to each of the loudspeakers as normal.



RM-4C8 WITH RM-HDE1, RM-E1X OR RM-E1B



Program Select Mode

A Dolby E source can contain up to and including 8 programs, each of which can be individually downmixed and monitored through the Reference Monitor. When a Dolby E source is presented to the expansion card input, it is possible to select each of these programs by entering the Program Select mode. A Dolby E source is indicated by the flashing of the dual function PROGS button. To enter Program Select mode press the PROGS button. The left-hand rotary Source selector and indicators are then used to select the programs within the Dolby E stream, dependent on the program configuration (see Table 4-1).

This control will only allow you to select the number of programs present within the stream. When selecting program numbers greater than 4, the indicator will wrap around to the top and all of the source indicators, with the exception of the current selection, will be illuminated a light green colour. As the Program selection is changed the downmix source will change dynamically and be reflected on the metering and loudspeakers. Once the required program has been selected, press the PROGS button to exit Program Select mode. The program downmix will remain selected until the input source changes or downmix mode is exited. It is always possible to see which Program is currently being monitored, by simply pressing the PROGS button to enter the Program Select mode and viewing the left hand source indicators. While in Program Select mode, the right hand rotary Source selector is disabled and the Left and Right channels are sent to the Left and Right loudspeakers respectively.

Multichannel Monitoring Mode

This mode is used to individually monitor and meter all the channels within the Dolby encoded stream. A Dolby Digital or Dolby E encoded source is indicated by the Green flashing of the dual function CHANS button. To enter Multichannel mode, press the CHANS button. When in Multichannel Monitoring mode the meters will change to dual-metering mode, whereby two channels are displayed on a single meter to allow the metering of all eight channels. The channel designators for the dual metering are displayed on front panel in inverse printing, with channels 1 & 2 being displayed on the first meter, channels 3 & 4 on the second, channels 5 & 6 on the third and channels 7 & 8 on the fourth and final meter. The channel assignments are dependent on the Program Config for Dolby E and the Coding Mode for Dolby Digital. Some of these assignments are shown below.

Dolby E Program Config or Dolby Digital Coding Mode	Channel Assignment							
	Ch 1	Ch 2	Ch 3	Ch 4	Ch 5	Ch 6	Ch 7	Ch 8
5.1 + 2	1L	1R	1C	1LFE	1Ls	1Rs	2L	2R
5.1 + 2 x 1	1L	1R	1C	1LFE	1Ls	1Rs	2C	3C
4 + 4	1L	1R	1C	1S	2C	2S	2L	2R
4 + 2 x 2	1L	1R	1C	1S	3L	3R	2L	2R
4 + 2 + 2 x 1	1L	1R	1C	1S	3C	4C	2L	2R
4 + 4 x 1	1L	1R	1C	1S	4C	5C	2C	3C
4 x 2	1L	1R	3L	3R	4L	4R	2L	2R
3 x 2 + 2 x 1	1L	1R	3L	3R	4C	5C	2L	2R
2 x 2 + 4 x 1	1L	1R	3C	4C	5C	6C	2L	2R
2 + 6 x 1	1L	1R	4C	5C	6C	7C	2C	3C
8 x 1	1C	2C	3C	4C	5C	6C	7C	8C
5.1	1L	1R	1C	1LFE	1Ls	1Rs	None	None
4 + 2	1L	1R	1C	1S	None	None	2L	2R
4 + 2 x 1	1L	1R	1C	1S	None	None	2C	3C
3 x 2	1L	1R	3L	3R	None	None	2L	2R
2 x 2 + 2 x 1	1L	1R	3C	4C	None	None	2L	2R
2 + 4 x 1	1L	1R	4C	5C	None	None	2C	3C
6 x 1	1C	2C	3C	4C	5C	6C	None	None
4	1L	1R	1C	1S	None	None	None	None
2 + 2	1L	1R	None	None	None	None	2L	2R
2 + 2 x 1	1L	1R	None	None	None	None	2C	3C
4 x 1	1C	2C	3C	4C	None	None	None	None
7.1	1L	1R	1C	1LFE	1Ls	1Rs	1Lr	1Rr
7.1 Screen	1L	1R	1C	1LFE	1Ls	1Rs	1Le	1Re
3/2L (DD)	1L	1R	1C	1LFE	1Ls	1Rs	None	None
3/2 (DD)	1L	1R	1C	None	1Ls	1Rs	None	None
2/2L (DD)	1L	1R	None	1LFE	1Ls	1Rs	None	None
2/2 (DD)	1L	1R	None	None	1Ls	1Rs	None	None
3/1L (DD)	1L	1R	1C	1LFE	1S	None	None	None
3/1 (DD)	1L	1R	1C	None	1S	None	None	None
2/1L (DD)	1L	1R	None	1LFE	1S	None	None	None
2/1 (DD)	1L	1R	None	None	1S	None	None	None
3/0L (DD)	1L	1R	1C	1LFE	None	None	None	None
3/0 (DD)	1L	1R	1C	None	None	None	None	None
2/0 (DD)	1L	1R	None	None	None	None	None	None
1/0 (DD)	None	None	1C	None	None	None	None	None
1 + 1 (DD)	1C	2C	None	None	None	None	None	None
PCM	1L	1R	None	None	None	None	None	None

Table 4-1: Program Configurations For Dolby E



RM-4C8 WITH RM-HDE1, RM-E1X OR RM-E1B



Each channel can be selectively routed to each loudspeaker using the two rotary Source selectors as in normal operation. When selecting channel numbers greater than 4, the indicator will wrap around to the top and all the source indicators, with the exception of the current selection will be illuminated a light green colour. Dolby Digital sources are limited to 6 channels in Multichannel monitoring mode. To exit Multichannel monitoring mode press the CHANS button.

Dual Metering Split Scale

Each meter shows 2 channels as standard with the 0dBFS for each channel at the top of each display section (bottom up mode). There is an option settable through the serial port which allows the 0dBFS scale of each section to be at the top and bottom respectively of the display (centre out mode).

The dual metering mode uses a modified AES Digital PPM configuration. The scale range is extended to -64dBFS to 0dBFS and the amber section starts at -4dBFS while the red section starts at 0dBFS.

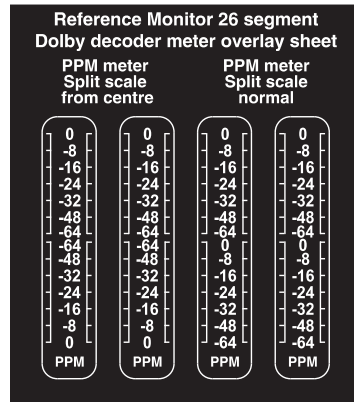

Fig 4-2: Dual Metering Chart

Serial Interface Commands & Responses Protocol

Sonifex Sci remote control software handles all communication with the Reference Monitors via a convenient graphical user interface. However, this protocol is provided for those users who wish to develop their own remote control applications or communicate with the Reference Monitors using a text-based terminal program.

For more information on how to install and operate the Sci software, please see page 62.

Serial Data Format

Connection is 19200,e,8,1 with XON/XOFF flow control.

Commands are case-insensitive and all parameters are in hex.

Commands should be terminated in a carriage return character, a line feed character may be sent but it will be ignored.

Further commands sent before the first command is acknowledged will be ignored. Responses will be CR & LF terminated.

After power up a welcome string is sent – "Initialising Sonifex Reference Monitor...done"

Remote Control Commands

Command	Description	Response
BSL:nn	- Select input Bank nn = 01 selects first Bank. nn = 02 selects second Bank, etc.	ACK:
DWN:*	- Download firmware update. Then send .DWN file as supplied.	ACK: ACK:
Faa:xxxxxxxxxyyyyyyyzzzzzzzzzz	- Set user-variable equalisation coefficients aa = EQ band number (01-05) xxxxxxxxxxx = five-byte coefficient 1 data. yyyyyyyyyyy = five-byte coefficient 2 data. zzzzzzzzzzz = five-byte coefficient 3 data.	ACK:
FPL:x	- Front panel lock Where: x = 0 unlocks the front panel. x = 1 locks the front panel (hex values 1 to F accepted and have same effect as 1). The front panel lock setting is not stored when power is lost.	ACK:
Gaa:	- Get user-variable equalisation coefficients Where: aa = EQ band number (01-05) xxxxxxxxxxx = five-byte coefficient 1 data. yyyyyyyyyyy = five-byte coefficient 2 data. zzzzzzzzzzz = five-byte coefficient 3 data.	Gaa: + data as for Faa

5 SERIAL INTERFACE COMMANDS & RESPONSES



SERIAL INTERFACE COMMANDS & RESPONSES

Command	Description	Response
LCK:	<p>- AES/EBU PLL Lock status Request</p> <p>Response depends on model type:</p> <p>RM-2S4 responds: LCK:x Where: x = lock status of selected stereo source. No further lock information is available.</p> <p>RM-2S10 responds: LCK:x+yyyyyyyyyy Where: x = lock status of selected stereo source. y = lock status of all ten AES inputs.</p> <p>RM-4C8 responds: LCK:xy+zxxx Where: x = lock status of left selected mono source. y = lock status of right selected mono source. z = lock status of four mono sources in currently selected bank. No lock data is available for an unselected bank.</p>	
LCK:ab	<p>- Set GPIO lock output logic preferences</p> <p>a = 0 selects normal polarity (lock = low/conducting output). a = 1 selects inverted polarity (lock = high/non-conducting output). b = 0 selects the logical OR of the LH & RH channel lock status. b = 1 selects the logical AND of the LH & RH channel lock status.</p>	ACK:
MOD:x,y	<p>- Remote control of audio Modifiers</p> <p>Where: x = modifier number, 0 to A (hex - values B to F accepted but have no effect). y = 0 to turn modifier off. y = 1 to turn modifier on (hex values 1 to F accepted and have same effect as 1). The modifier numbers are: 0 = DIM, 1 = CUT L, 2 = CUT R, 5 = MONO, 6 = PHASE INVERT and 7 = M+S</p>	ACK:
OPT:x,yy	<p>- Set technical options</p> <p>x = option number (1...F in hex) yy = new value for option parameter (00...FF in hex) All OPT settings are stored in non-volatile memory and retained during power loss.</p>	ACK:
OPT:1,xx	<p>- Turn off presence detection:</p> <p>Where: x = 00 enables the presence detectors (default setting). x = 01 disables the presence detectors (hex values 01 to FF accepted and have same effect as 01).</p>	ACK:

Command	Description	Response
OPT:2,xx	Source autodetection for RM-2S10 (see page 6): Where: x = 00 selects normal operation (default setting) x = 01 enables source autoselection (hex values 01 to FF accepted and have same effect as 01). The SRQ: query will correctly report the bank currently in use. The UID: query will report a single bank of 10 sources rather than two when autoselect is enabled.	ACK:
SER:	- Serial Number request	SER:nnnnnn
SRQ:	- Status request Where: x = current bank number (1...n). y = current source number for LH speaker (1...n). z = current source number for RH speaker (1...n).	SRQ:BxLyRz
SS1:nn	- Set Left-hand Source nn = Source number, starting with 01.	ACK:
SS2:nn	- Set Right-hand Source nn = Source number, starting with 01.	ACK:
UID:*	- Unit ID Request Where: x = number of sources available in each of banks 1-6 y = dependent on Banks fitted.	UID:RM4:V11yyyy or UID:RM-2S4-xxxxxx or UID:RM-2S10-xxxxxx or UID:RM-4C8-xxxxxx or UID:RM4/A (bootloader)
VER:*	- Firmware Version Request	VER:n.nn or BOOT:n.nn (bootloader)

* = these commands also valid in Bootloader mode.

Error Messages

ERR:01	- returned if Command Not Found.
ERR:02	- returned if Missing Parameter.
ERR:04	- returned if Parameter out of range.
ERR:08	- returned if Checksum Error occurs during reprogramming.

Firmware Updates

The internal firmware of the Reference Monitors can be updated to take advantage of newly added features. It is recommended that this be done using the Sonifex SCi remote control package, but it may also be done using the command protocol provided and the "Send Text File" (or similar) facility in text-based terminal programs such as Hyperterminal. When prompted for a filename, locate and select the .DWN file provided with the firmware update.



5 SERIAL INTERFACE COMMANDS & RESPONSES



SERIAL INTERFACE COMMANDS & RESPONSES

If using a terminal program, to achieve reliable data transfer the Line Delay (found under File>Properties>Settings>ASCII Setup in Hyperteminal) should be set to 20ms.

It is vital that neither the serial connection nor mains power to the Reference Monitor should be interrupted during the update process. If this should happen, or the update is unsuccessful for any other reason, the Reference Monitor will not operate normally and will instead enter a protected Bootloader mode. In this mode, the unit has a limited command set and will await a successful retry of the update process.

Should the firmware update appear to succeed but the unit not behave as expected, the update may be repeated either via the DWN: command (if the unit will respond to commands) or, in extreme circumstances, by setting switch number 12 in Block 1 of configuration switches (found on the underside of the unit) to ON. This action will force the Bootloader to run and allow initiation of an update under any circumstances. After completion of the update, the switch should be returned to the OFF position.

User-Variable EQ Parameter Format

The DSP coefficients for the user-variable EQ need to be pre-calculated before being sent to the Reference Monitor.

Each band of EQ is a parametric equaliser with the following parameters:

F = centre frequency in Hz,

BW = bandwidth in octaves

G = height of peak/trough at centre frequency (linear, so 6dB=2.0, 12dB=4.0, etc)

First, the following intermediate values should be calculated:

$$\mathbf{R} = ((2^{BW})-1)/(2^{BW/2})$$

$$\mathbf{K} = \tan(\pi F/48000)$$

$$\mathbf{A} = G - 1$$

From these, the three coefficients M1, M2 and M3 can be calculated. They differ according to whether boost or cut is required.

If boost is required:

$$\mathbf{M1} = (A * R * K) / (1 + (R * K) + (K^2))$$

$$\mathbf{M2} = (4 * (K^2)) / (1 + (R * K) + (K^2))$$

$$\mathbf{M3} = (1 - (R * K) + (K^2)) / (1 + (R * K) + (K^2))$$

If cut is required:

$$\mathbf{M1} = -(A * R * K) / (1 + (G * R * K) + (K^2))$$

$$\mathbf{M2} = (4 * (K^2)) / (1 + (G * R * K) + (K^2))$$

$$\mathbf{M3} = (1 - (G * R * K) + (K^2)) / (1 + (G * R * K) + (K^2))$$

The resulting three coefficients should then be converted to S3.24 format, i.e. one sign bit, three integer bits and 24 fractional bits. It is in this format that they are sent to the Reference Monitor. A five-byte string (five hex character pairs) is sent with the coefficient bytes sent MSB first. The upper nibble of the MSB should be all zeros.

Coefficient updates will be applied instantly.





Reference Monitor SCI Remote Control Software

Sonifex SCI software is free of charge software available to control the Reference Monitor range of audio monitors, as well as other Sonifex products, using either RS232 or USB connections.

Download the Latest SCI Software

This is located on the Sonifex website in the Software Downloads section:
<http://www.sonifex.co.uk/technical/software/index.shtml>

Download and install the software.

Connecting Using USB Port

Before the Reference Monitor can be used with the SCI software, you need to install the latest version of the USB drivers. These can be found on the Sonifex website located in the 'Sonifex Reference Monitor' section of Software Downloads:

<http://www.sonifex.co.uk/technical/software/index.shtml>

Once you have downloaded the drivers, unzip them to a suitable folder. Connect the Reference Monitor to your computer using a USB cable and power up the Reference Monitor.

The 'Found New Hardware' wizard will pop up and you are ready to begin installation. If Windows asks to connect to the internet to find the drivers, select the option 'Not this Time', click 'Next', and select the option 'I Will Choose The Driver To Install'. Point the wizard to the directory into which you unzipped the USB driver files and continue with the installation.

Connecting using the RS232 Serial Port

You do not need to download drivers when connecting via this method. Simply connect your Reference Monitor to your computer using a serial cable and you are ready for operation.

Using SCI For The First Time

Once you are connected, double click the SCI icon. You will be presented with the SCI Launcher:

Click on the large 'Plus' button and the software will try and communicate with the relevant serial ports to 'discover' your connected devices.



Fig 6-1: SCI Launcher

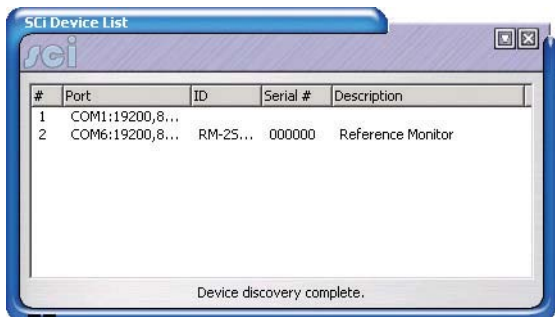

Fig 6-2: SCI Device Discovery Panel

Your attached Reference Monitor(s) will be shown in the list. If they are not listed, check the cable(s) between the Reference Monitor and your PC.



Fig 6-3: SCI Device Information Panel

Close the device dialog by clicking on the cross in the top right corner. The Reference Monitor now appears in the SCI Launcher.

Loaded Launcher

Double-click on this to gain access to the Reference Monitor controls.



Fig 6-4: SCI Launcher Loaded

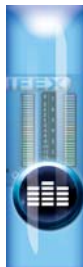

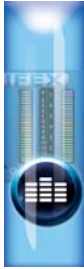

Sci For Reference Monitors

The graphical interface allows you to control the Reference Monitor remotely. Bank/Source Selection, Dolby Decoding Channel and Program options, front panel Modifier controls, EQ parameter adjustment, firmware updating, Dolby metadata and miscellaneous options can all be accessed and adjusted from this main panel. Please note that Sci is continuously updated so the images may appear differently to those below



Fig 6-5: Sci Main Screen Showing Dolby Digital Monitoring

Bank & Source Selection & Editing

On the left hand side of the 'Main' tab you have the ability to select Banks and their respected Sources and to edit their names. Depending upon the model of your Reference Monitor, or if expansion cards are fitted, the number of available Banks varies. Each Bank shows its respected Sources and you can edit the names of the Sources for each Bank.

To edit a Source or Bank name, click on the Edit icon located on the bottom left of the screen and then click on the Source or Bank that you wish to edit. Type the Source or Bank name into the text box and press 'Enter' on the keyboard. Press the Cancel button before hitting the 'Enter' key to cancel the process.



Fig 6-6: Sci Main Screen Showing Dolby E Monitoring

If an optional Dolby Decoding card is fitted, then Dolby Decoded channels and Dolby Decoded Programs can be monitored. One of the benefits of using SCI for the monitoring is that the multiple channel names and Program names can be shown.



Fig 6-7: SCI Main Screen Showing Dolby Digital Programs

Front Panel Modifiers

These are a replication of the front panel Reference Monitor functions which offer 'Dim, Mono, Left Cut, Right Cut, Phase Invert, and M+S (Middle + Side)' selection. The status of these are automatically recalled from the Reference Monitor and changes on the Reference Monitor are reflected in SCI and vice-versa.

A Front Panel Lock button is also included and when active disables the functionality of the Reference Monitor front panel. However you will still have full control from within SCI.

5 Band Parametric Equalizer

The 5 band parametric EQ built into the Reference Monitors is only available using serial control, so using SCI is an easy way to configure the EQ.

The 5 bands are shown on the 'User EQ' tab and an 'EQ Preset' box allows you to select default presets. The default presets cannot be edited. However you can generate preset settings yourself, called Custom EQ Settings, which you can save off.

To create a new EQ preset, click the 'New' Icon on the top toolbar. You will now be in EQ edit mode. Click the Enable button for the EQ band that you wish to adjust, e.g. Band 1. This will activate the EQ for that selected band.

By clicking in the Frequency, Bandwidth and Gain edit boxes for Band 1, the 3 EQ faders respectively are enabled for that band and can be adjusted to your taste. The values are updated as you drag the faders, but are only sent to the Reference Monitor once you have released the mouse click. Please note that the sound output of the Reference Monitor takes a few seconds to stabilise once a new set of EQ parameters has been loaded.

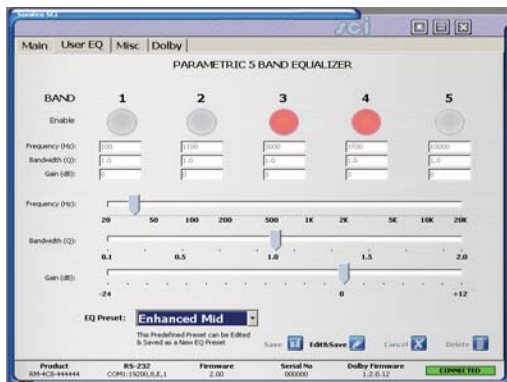

Fig 6-8: SCI User EQ Screen

You can navigate through the rest of the Band edit boxes by either clicking in them with your mouse, or by using Tab on your keyboard. The values in the edit boxes can also be adjusted manually by typing in values. A bevel appears around the band that you are editing.

Once you are happy with the EQ preset that you are defining, click the Save Button on the top toolbar. A text edit box appears for you to type in the name of your new preset. Press the 'Enter' key to Save the preset name. The name now appears in the 'EQ Preset' box, available for selection. You can also edit and save over existing Custom EQ Settings.

When SCI first connects to a Reference Monitor, it reads its current EQ settings. If these EQ parameters match up with a known EQ Preset, then that preset is loaded in. If not, then the EQ settings are shown as a 'Recalled Preset'. This can be saved as a New Preset if you wish.

To Delete an EQ Preset, select the Preset and then press the Delete button at the top of the screen.

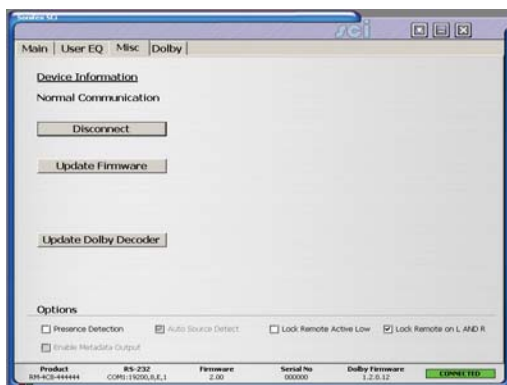

Fig 6-9: SCI Misc Screen

Firmware Updates

The 'Misc' screen shows the Update Firmware option and other miscellaneous options available, such as enabling Presence Detection. Click on the Update Firmware button to install new firmware on the connected Reference Monitor. This screen can also be used to update firmware on the optional Dolby Decoding card.

Dolby Metadata

The 'Dolby' screen allows Dolby metadata to be viewed if an optional Dolby Decoding card has been fitted.



Fig 6-10: Dolby Screen Showing Dolby Digital Metadata



Fig 6-11: Dolby Screen Showing Dolby E Metadata

NOTES



NOTES



NOTES

SONIFEX

www.sonifex.co.uk

t:+44 (0)1933 650 700

f:+44 (0)1933 650 726

sales@sonifex.co.uk

interstage

Phistersvej 31, 2900 Hellerup, Danmark
Telefon 3946 0000, fax 3946 0040
www.interstage.dk



- pro audio with a smile

