

DHY-03

Digital Telephone Hybrid **User Handbook**



interstage

Phistersvej 31, 2900 Hellerup, Danmark
Telefon 3946 0000, fax 3946 0040
www.interstage.dk

- pro audio with a smile



SONIFEX



This handbook is for use with the following products :

DHY-03	Automatic digital TBU, free standing
DHY-03S	Automatic digital TBU, 19" rack mounted
DHY-03T	Twin automatic digital TBU, 19" rack mounted
DHY-03EC	Automatic digital TBU, eurocard

©Sonifex Ltd, 2007

All Rights Reserved

Revision 1.05, March 2007

Sonifex Ltd, 61, Station Road, Irthlingborough,
Northants, NN9 5QE, England.

Tel: +44 (0)1933 650 700

Fax: +44 (0)1933 650 726

Email: sales@sonifex.co.uk

Website: <http://www.sonifex.co.uk>

Information in this document is subject to change without notice and does not represent a commitment on the part of the vendor. Sonifex Ltd shall not be liable for any loss or damage whatsoever arising from the use of information or any error contained in this manual.

No part of this manual may be reproduced or transmitted in any form or by any means, electronic or mechanical, including photocopying, recording, information storage and retrieval systems, for any purpose other than the purchaser's personal use, without the express written permission of Sonifex Ltd. Unless otherwise noted, all names of companies, products and persons contained herein are part of a completely fictitious adaptation and are designed solely to document the use of Sonifex product.

Contents

Warranty	i
Warranty and Liability	i
Unpacking the DHY-03	iii
Returning the Warranty Card	iii
Safety Information	iv
Safety of Mains Operated Equipment	iv
Voltage Setting Checks	iv
Fuse Rating	iv
Power Cable and Connection	v
Opening the DHY-03	v
Power For DHY-03EC	v
Ordering the Correct Mains Lead	vi
Installation Information	vi
Atmosphere	vi
Electromagnetic Radiation	vi
WEEE & RoHS Directives - Sonifex Statement	vii
Reporting Faults	viii
1 Introduction	1
What is a Telephone Hybrid ?	2
Available Formats	2
Model DHY-03 Automatic digital TBU	3
Model DHY-03S Automatic digital TBU	3
Model DHY-03T Twin automatic digital TBU	3
Model DHY-03EC Eurocard automatic digital TBU	3
Connecting the DHY-03 TBU	4
Using the DHY-03	5
First Use	5
Using the DHY-03 with the Broadcast Bionics PhoneBox	5
Using the DHY-03 with Internal Telephone Exchanges	5
Receiving a Call	6
<i>Integrated Ringing Detector – Auto Answer</i>	6
Making a Call	6
Call Established	7
<i>Level Setting</i>	7
<i>DTMF Detection</i>	7
<i>Integrated Disconnect Detector – Auto Disconnect</i>	7
Conference Calls	7
<i>Using the Conference Port as a Record Output</i>	8
2 Configuration & Controls - DHY-03, DHY-03S, DHY-03T	9
Front Panel Controls	9
Power LED Indicator	9
Line Connect Button	9
Gain Switches	9
LED Bargraphs	9
Status & Operating Mode Information	10
Reset Button	11
Rear Panel Controls	11
Adjusting the Microphone Gain Level	11
Mic/Line Input Select Switch	11
Configuration Settings Switches	11

Noise Gate Select - SW1 {ON}	12
Ducking Enable - SW2 {ON}	12
Auto Disconnect Enable - SW3 {ON}	12
Ring Detector (Auto Answer) Enable - SW4 {ON}	12
Acoustic Cancellation Enable – SW6 {OFF}	13
Network Cancellation Enable – SW7 {ON}	13
Country Set on Power Up – SW8 {OFF}	13
Remotes	13
RS232 Serial Port	13
DHY-03 Internal Controls & Adjustments	14

Configuration & Controls - DHY-03EC 15

Controls 15

Power LED Indicator	15
Gain Jumpers	15
Tricolour LED Level Indicators	15
Status & Operating Mode Information	16
Reset Button	16
Configuration Settings Switches	16
Noise Gate Select - SW1 {ON}	17
Ducking Enable - SW2 {ON}	17
Auto Disconnect Enable - SW3 {ON}	17
Ring Detector (Auto Answer) Enable - SW4 {ON}	17
Acoustic Cancellation Enable – SW6 {OFF}	17
Network Cancellation Enable – SW7 {ON}	17
Country Set on Power Up – SW8 {OFF}	17
Momentary Latching Function - SW9 {OFF}	18
Debug Function - SW10 {OFF}	18
Remotes	18
RS232 Serial Port	18
Jumper and Select Switcher Functions	18

Country Code Selection 19

Hybrid Technical Description 21

Electrical Interface	21
Impedance Matching	22
Echo Cancellation	22
Calibration of DHY-03 Hybrid	22
Calibration of Telephone Interface	23
Calibration of Network Cancellation Coefficients	23
Acoustic Cancellation	23
Updating Firmware	23

3 Serial Port Control 24

DHY-03 Serial Connection 24

Normal Mode	24
Setting Mode	24
Bootstrap Mode	24
SCI Software	24

Serial Interface Commands & Responses 24

Normal Mode Commands	24
Setting Mode Commands	25
Bootstrap Mode Commands	25
Status Request Responses	25
Error Messages	26

DHY-03 Serial Parameters 26

Parameter Numbers – Function and Value	26
Extended Parameter Description	28
Calibration Register – parameter 3	28

Telephone Interface Meter Select – parameters 7	28
Disconnect Type – parameters 25,50,75,100,125,150,175	29
Telephone Interface Hybrid Pointer – parameters 26,51,76,101,126,151,176	29
Telephone Interface Register 16 - parameters 28,53,78,103,128,153,178	29
Telephone Interface Register 17 - parameters 29,54,79,104,129,154,179	29
Telephone Interface Register 18 - parameters 30,55,80,105,130,155,180	30
Telephone Interface Register 22 - parameters 31,56,81,106,131,156,181	30
Telephone Interface Register 23 - parameters 32,57,82,107,132,157,182	30
Telephone Interface Register 24 - parameters 33,58,83,108,133,158,183	31
Telephone Interface Register 26 - parameters 34,59,84,109,134,159,184	31
Telephone Interface Register 30 - parameters 35,60,85,110,135,160,185	31
AC Impedance Setting	32
Telephone Interface Register 31 - parameters 36,61,86,111,136,161,186	32
Telephone Interface Register 59 - parameters 37,62,87,112,137,162,187	32
Telephone Interface Adaptation Differential – parameters 43,68,93,118,143,168,193	33
Telephone Interface Adaptation Response – parameters 44,69,94,119,144,169,194	33
Disconnect Tones – parameters 200,208,216,224,232,240	33
Cadence Pattern 1 – parameters 201,209,217,225,233,241	34
Success Time/Cadence Pattern 2 – parameters 202,210,218,226,234,242	34
Cycles for Transform – parameters 203,211,219,227,235,243	34
Coefficient for Tone 1 – parameters 204,212,220,228,236,244	34
Coefficient for Tone 2 – parameters 205,213,221,229,237,245	34
Threshold Level – parameters 206,214,222,230,238,246	34

4 Technical Specification

35

DHY-03 Connection Details

35

Line Output

35

Mic/Line Input

35

Remotes

36

RS232 Serial Port

36

Telephone Handset

37

Telephone Line

37

Telephone Connections

37

Conference Audio/Record Output

37

Mains Input

37

Protective Earth Terminal

37

DHY-03EC I/O Connector

38

Technical Specification

39

Physical Specification

39

Accessories

40

Divert Relay Function

40

Approvals Information

40





Figures	
Table A : Packing List.	iii
Table B : Power Connections.	v
Table C : Mains Lead Table.	vi
Figure 1-1 : DHY-03 Front & Rear.	3
Figure 1-2 : DHY-03S Front & Rear.	3
Figure 1-3 : DHY-03T Front & Rear.	3
Figure 1-4 : DHY-03EC View From Above.	3
Figure 1-5 : DHY-03 User Connections.	4
Figure 1-6 : Audio Paths for Conference Call.	8
Figure 1-7 : Conference Port Cable Connections.	8
Figure 2-1 : Front Panel Controls.	9
Figure 2-2 : Rear Panel Controls.	11
Figure 2-3 : Configuration Settings Switches.	12
Figure 2-4 : Rear Panel Controls.	13
Figure 2-5 : PCB Layout.	14
Figure 2-6 : DHY-03EC Controls.	15
Figure 2-7 : DHY-03EC Configuration Settings Switches.	16
Figure 2-8 : DHY-03EC Diagram.	18
Table 2-1 : Supported Disconnect Tone Details by Country.	21
Table 2-2 : Calibration Parameter Settings.	22
Table 3-1 : Meter Select Parameter Values.	28
Table 3-2 : Disconnect Type Parameter Values.	29
Table 3-3 : Telephone Interface Register 16.	29
Table 3-4 : Telephone Interface Register 17.	29
Table 3-5 : Telephone Interface Register 18.	30
Table 3-6 : Telephone Interface Register 22.	30
Table 3-7 : Telephone Interface Register 23.	30
Table 3-8 : Telephone Interface Register 23 - RTO Values.	30
Table 3-9 : Telephone Interface Register 23 – RCC Values.	30
Table 3-10 : Telephone Interface Register 24.	31
Table 3-11 : Telephone Interface Register 26.	31
Table 3-12 : Telephone Interface Register 30.	31
Table 3-13 : Telephone Interface Register 30 - AC Impedance settings.	32
Table 3-14 : Telephone Interface Register 31.	32
Table 3-15 : Telephone Interface Register 59.	32
Table 3-16 : Adaptation Differential Parameter Values.	33
Table 3-17 : Adaptation Response Parameter Values.	33
Table 3-18 : Table of Disconnect Tone Values.	33
Figure 4-1 : DHY-03 Rear Panel Connections.	35
Table 4-1 : Technical Specification.	39
Table 4-2 : Physical Specification.	39
Table 4-3 : Accessories.	40

Warranty

Warranty and Liability

Important: the purchaser is advised to read this clause

- (a) The Company agrees to repair or (at its discretion) replace Goods which are found to be defective (fair wear and tear excepted) and which are returned to the Company within 12 months of the date of despatch provided that each of the following are satisfied:
- (i) notification of any defect is given to the Company immediately upon its becoming apparent to the Purchaser;
 - (ii) the Goods have only been operated under normal operating conditions and have only been subject to normal use (and in particular the Goods must have been correctly connected and must not have been subject to high voltage or to ionising radiation and must not have been used contrary to the Company's technical recommendations);
 - (iii) the Goods are returned to the Company's premises at the Purchaser's expense;
 - (iv) any Goods or parts of Goods replaced shall become the property of the Company;
 - (v) no work whatsoever (other than normal and proper maintenance) has been carried out to the Goods or any part of the Goods without the Company's prior written consent;
 - (vi) the defect has not arisen from a design made, furnished or specified by the Purchaser;
 - (vii) the Goods have been assembled or incorporated into other goods only in accordance with any instructions issued by the Company;
 - (viii) the defect has not arisen from a design modified by the Purchaser;
 - (ix) the defect has not arisen from an item manufactured by a person other than the Company.

In respect of any item manufactured by a person other than the Company, the Purchaser shall only be entitled to the benefit of any warranty or guarantee provided by such manufacturer to the Company.

- (b) In respect of computer software supplied by the Company the Company does not warrant that the use of the software will be uninterrupted or error free.
- (c) The Company accepts liability:



- (i) for death or personal injury to the extent that it results from the negligence of the Company, its employees (whilst in the course of their employment) or its agents (in the course of the agency);
 - (ii) for any breach by the Company of any statutory undertaking as to title, quiet possession and freedom from encumbrance.
- (d) Subject to conditions (a) and (c) from the time of despatch of the Goods from the Company's premises the Purchaser shall be responsible for any defect in the Goods or loss, damage, nuisance or interference whatsoever consequential economic or otherwise or wastage of material resulting from or caused by or to the Goods. In particular the Company shall not be liable for any loss of profits or other economic losses. The Company accordingly excludes all liability for the same.
- (e) At the request and expense of the Purchaser the Company will test the Goods to ascertain performance levels and provide a report of the results of that test. The report will be accurate at the time of the test, to the best of the belief and knowledge of the Company, and the Company accepts no liability in respect of its accuracy beyond that set out in Condition (a).
- (f) Subject to Condition (e) no representation, condition, warranty or other term, express or implied (by statute or otherwise) is given by the Company that the Goods are of any particular quality or standard or will enable the Purchaser to attain any particular performance or result, or will be suitable for any particular purpose or use under specific conditions or will provide any particular capacity, notwithstanding that the requirement for such performance, result or capacity or that such particular purpose or conditions may have been known (or ought to have been known) to the Company, its employees or agents.
- (g) (i) To the extent that the Company is held legally liable to the Purchaser for any single breach of contract, tort, representation or other act or default, the Company's liability for the same shall not exceed the Price of the Goods.
- (ii) The restriction of liability in Condition (g)(i) shall not apply to any liability accepted by the Seller in Condition (c).
- (h) Where the Goods are sold under a consumer transaction (as defined by the Consumer Transactions (Restrictions on Statements) Order 1976) the statutory rights of the Purchaser are not affected by these Conditions of Sale.

Unpacking the DHY-03

The DHY-03 is shipped with the following equipment. Please check your packaging to ensure that you have all of the items below. If anything is missing, please contact the supplier of your equipment immediately.

Item	Quantity	Quantity	Quantity
	DHY-03 & DHY-03S	DHY-03T	DHY-03EC
DHY-03 automatic telephone hybrid	1	2	1
Telephone line lead (RJ11 to RJ11)	1	2	-
Telephone line lead (RJ11 to BT plug)	1	2	-
Telephone line lead adapter (BT socket to RJ11 plug)	1	2	-
IEC Mains lead fitted with moulded mains plug	1	2	-
Handbook and warranty card	1	1	1

Table A: Packing List.

Each DHY-03 is shipped in protective packaging and should be inspected for damage before use. Where an item is found to have transit damage, notify the carrier immediately with all the relevant details of the shipment. Packing materials should be kept for inspection and also for if the product needs to be returned.

Returning the Warranty Card

In order to register the date of purchase so that we can keep you informed of any design improvements or modifications, it is important to complete the warranty registration document that is enclosed and return it to Sonifex Ltd in the UK, or register online at www.sonifex.co.uk/register

For your own records you should write down the serial number (which can be found on the rear of the DHY-03 or on the connector on the DHY-03EC).

Serial Number
---------------	-------



Safety Information

Safety of Mains Operated Equipment



This equipment has been designed to meet the safety regulations currently advised in the country of purchase and it conforms to the safety regulations specified by use of the CE Mark.

Warning : There are no user serviceable parts inside the equipment. If you should ever need to look inside the unit, always disconnect the mains supply before removing the equipment covers.

Warning: The DHY-03 line socket should only be connected with apparatus complying with BS6301, and the connection to the network must not be hard wired Interconnection directly or indirectly with equipment ports marked in accordance with BS6301 to unmarked ports may produce hazardous conditions on the network and advice should be obtained from a competent engineer before such a connection is made.

Warning: This apparatus must be earthed by means of the earth connector on the rear panel, and the connection to the telecommunications network should be removed before disconnecting the earth. Disconnection of this earth connection may render the equipment unsafe, with a consequential possible electrical shock hazard from exposed metallic parts.

Warning: The barriered ports 'LINE' and 'HANDSET' must not be connected directly or indirectly to the un-barriered ports, 'MIC/LINE INPUT', 'OUTPUT', 'CONFERENCING', 'REMOTES' or 'RS-232'.

Voltage Setting Checks

The integral power supply is designed to accept a universal input of 85 to 264 VAC mains input voltage. The safety specification of your DHY-03 complies with local requirements and must be earthed through the mains connector.

Fuse Rating

The DHY-03 is supplied with a single fuse in the live conducting path of the mains power input. For reasons of safety it is important that the correct rating and type of fuse is used. Incorrectly rated fuses could present a possible fire hazard, under equipment fault conditions. The fuse rating for DHY-03 is:

230 or 115 V operation - 1A 5 x 20mm SB

The active fuse is fitted on the outside rear panel of the unit.

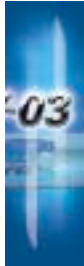

Power Cable and Connection

An IEC power connector is supplied with the DHY-03 which has a moulded plug attached – this is a legal requirement. If no moulded plug has been supplied with your DHY-03, please contact your supplier, because an IEC connector is always supplied from the Sonifex factory.

If for any reason, you need to use the DHY-03 with a different power cable, you should use the following wiring guidelines

Wire Colour	Connection
Green, or green and yellow	Earth (E)
Blue, or Black	Neutral (N)
Brown, or Red	Live (L)

Table B : Power Connections.

Connect the equipment in accordance with the connection details and before applying power to the unit, check that the machine has the correct operating voltage for your mains power supply.

Important Note : The terminal marked on the rear panel must be earthed.

Opening the DHY-03

If you need to get inside the unit to make configuration adjustments, simply remove the 4 screws in the corners of the rear panel. The rear panel and main PCB will slide backwards out of the metal chassis.

Warning : The power must be switched off at the supply or the power lead must be disconnected before attempting to open the unit. Removal of the cover can expose dangerous voltages.

Warning : The telephone line plug should be disconnected from the telecommunications network exchange line before removing the equipment covers.

Power For DHY-03EC

The DHY-03EC requires an extended DC supply of 5V or 15V (jumper selectable). This supply should be isolated.

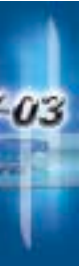

Ordering the Correct Mains Lead

When ordering a TBU from Sonifex, it is helpful if you can specify your required operating voltage and mains lead. After the product code add:

UK, for 230V, UK 3 pin to IEC lead



EC, for 230V, European Schuko 2 pin to IEC lead



US, for 115V, 3 pin to IEC lead



AU for 230V, Australasian 3 pin to IEC lead



Table C: Mains Lead Table.

E.g. order DHY-03S UK for a UK IEC lead to be supplied.

Installation Information

Atmosphere

The units should be installed in an area that is not subject to excessive temperature variation ($<0^{\circ}\text{C}$, $>50^{\circ}\text{C}$), moisture, dust or vibration.

Electromagnetic Radiation

The cover is connected to earth by means of the fixing screws. It is essential to maintain this earth ground connection to ensure a safe operating environment and provide electromagnetic shielding.

WEEE & RoHS Directives - Sonifex Statement



The Waste Electrical and Electronic Equipment (WEEE) Directive was agreed on 13 February 2003, along with the related Directive 2002/95/EC on Restrictions of the use of certain Hazardous Substances in electrical and electronic equipment (RoHS).

The **Waste Electrical and Electronic Equipment Directive (WEEE)** aims to minimise the impacts of electrical and electronic equipment on the environment during their life times and when they become waste. It applies to a huge spectrum of products. It encourages and sets criteria for the collection, treatment, recycling and recovery of waste electrical and electronic equipment. All products manufactured by Sonifex Ltd have the WEEE directive label placed on the case. It gives a contact for individuals who are unsure about the correct procedure when the product has reached its "end of use".

Sonifex Ltd will be happy to give you information about local organisations that can reprocess the products, or alternatively all products that have reached "end of use" can be returned to Sonifex and will be reprocessed correctly free of charge.

Sonifex Ltd has phased out the use of certain hazardous substances identified in the European Union's **Restriction of Hazardous Substances (RoHS)** directive. The RoHS directive limits the use of certain hazardous substances currently used in EEE manufacture, including lead, mercury, cadmium, hexavalent chromium, and halide-containing compounds PBB (polybrominated biphenyl) and PBDE (polybrominated diphenyl ether). Elimination of these substances will result in more environmentally friendly recycling of electronic equipment. For the products which Sonifex manufacture, the main area where products were affected was in the use of lead for manufacturing and assembling electronics circuit boards.

Sonifex Ltd practices lead-free (LF) manufacturing processes. LF solder is used on the surface-mount PCB manufacturing processes and for hand soldering. The printed circuit boards (PCBs) used are either gold plated, or immersion tin plated, both of which use no lead. Historically the PCBs were hot air solder levelled (HASL) PCBs which used tin/lead based solder.

The manufacturing processes include the assembly of purchased components from various sources. Product is offered as RoHS compliant, or LF, only after sufficient evidence is received from the component manufacturers that their components are RoHS compliant. Sonifex Ltd relies solely on the distributor, or manufacturer, of the components for identification of RoHS compliance. Thus whilst every effort is made to ensure compliance, Sonifex Ltd makes no warranty, or certification, or declaration of compliance concerning said components.

Sonifex Ltd defines "Lead Free" as pertaining to any product, which has been manufactured by Sonifex Ltd using components which have been declared by the manufacturers as "Lead Free". All statements by Sonifex Ltd of RoHS compliance are based on component manufacturer documentation.





Reporting Faults

Although this Sonifex product is manufactured to the highest standards, it is possible that minor faults may appear in the equipment over its normal lifetime. If you find any problems with the DHY-03, please contact your Sonifex distributor, or contact Sonifex directly at the following address, or fax with a copy of this completed sheet :

To :	From:
Sonifex Ltd,	Name
61, Station Road,	Position
Irthlingborough,	Company
Northants.	Address
NN9 5QE, UK	
Tel : +44 (0)1933 650 700	Tel
Fax : +44 (0)1933 650 726	Fax
Email : technical.support@sonifex.co.uk	Email

For the Serial No. of your machine, see the back panel of the DHY-03 unit.

DHY-03 Serial No.

Please describe the error in as much detail as possible (for example what you were doing when the problem occurred, what actually happened, etc)

Description of DHY-03 Error

Also, if you have any suggestions for additions or upgrades to the DHY-03 unit , we would like to hear what they are :

Additions that I Would Like to See

1 Introduction

The DHY-03 is a high quality digital telephone hybrid, which is suitable for most general telephony applications and is often used in radio and TV stations, bingo halls and dealing floors. The digital DHY-03 telephone hybrid is the replacement for the DHY-02, which for many years has set the standard as an excellent value, high quality telephone hybrid. The DHY-03 can be used for any application where a clean telephone signal is required and the line is not subject to excessive delay. The DHY-03 retains many of the features of the DHY-02 and adds some additional ones. Some of the features of the DHY-03 include:

- Fully automatic - adapts to varying line conditions and has automatic signal limiting.
- Fully adaptive echo cancellation to 127msec - default is 24msec.
- 75dB typical line balance rejection offering superb performance and crystal clear audio.
- Front panel input and output gain controls (jumpers on DHY-03EC).
- Front panel LED metering of receive and send signals.
- Built-in conferencing for 2 hybrids, so that a single telco channel on a mixing desk can receive 2 calls (unavailable on DHY-03EC).
- Integrated ring detector - automatic call answering after a pre-determined number of rings.
- Automatic call disconnection. Fitted with K-break, line polarity reversal and dial tone disconnect detection, defined by the country selection.
- Automatic ducking facility allows the talent to 'shout-down', or talk over, a caller by reducing the gain of the caller's signal if it goes above a certain level.
- Local and remote line hold switching - calls can be remotely switched through a mixing console.
- Line hold/release button to control line hold circuit, illuminates to indicate the status of the line and flashes to show ring status.
- DTMF tone recognition allowing a opto-isolated GPI output to be made on receipt of selected DTMF tones, e.g. for starting a studio automation recorder automatically to record a remote telephone interview.
- International operation with built-in configurable settings for each country. Country selection allows the unit to provide line impedance and a simulation circuit to match the country.
- RS232 serial port for remote control of the TBU, DTMF tone dialling and firmware upgrades to add new country settings.





- Remote port distributes the remote line connect switch and tally output, a momentary/latch selector and the DTMF detect output.
- The remote line connect switch can be either momentary or latching in its action.
- Balanced mic/line input - 10k balanced input selectable for 0dBu clean feed line, or microphone level with adjustable gain (line input only on DHY-03EC).
- Divert relay (for new units, see page 40).
- Balanced output - 0dBu low impedance balanced output, with output gain settings.
- Record output - the conferencing output can be set via a jumper to give a mix of the caller and mic/line input signals for recording both sides of the telephone conversation (unavailable on DHY-03EC).
- Line limiter, bandpass filter and output noise gate with preset threshold providing low distortion audio.
- Built in universal power supply between 90V AC and 250V AC, 47-63Hz, IEC mains input (external DC required by DHY-03EC).
- ETSI approval compliant with European PTT specifications.

What is a Telephone Hybrid ?

Telephone hybrids (or telephone balance units, TBUs) provide the interface between professional audio equipment and the public telephone network. They provide protection for your equipment and the public telephone lines, allowing for varying line signals and line conditions. Automatically cancelling out the unwanted signal they also facilitate two-way communication down a single telephone line, converting the two-wire telephone signal to a four-wire send and return signal to be linked to a studio mixer, for example.

The hybrid has a telephone line connection and separate terminals for audio input and output from a broadcast mixer, or other professional audio source.

A large proportion of Sonifex hybrids are used in radio and television broadcasting applications for allowing external callers to be connected to the studio mixing console. Most of the other units are supplied to communication operations for allowing extremely effective conversion between four-wire audio circuits and standard telephone lines.

Built to a very high specification, the DHY-03 is simple to install and automatically adapts to line conditions and programme content.

Available Formats

The DHY-03 digital telephone hybrids are available in four different formats. Three modules have their own approved, integrated power supply and the DHY-03EC requires an external DC supply:

Model DHY-03 Automatic digital TBU



Figure 1-1 : DHY-03 Front & Rear.

Model DHY-03S Automatic digital TBU



Figure 1-2 : DHY-03S Front & Rear.

Model DHY-03T Twin automatic digital TBU

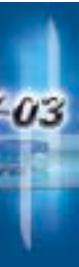

Figure 1-3 : DHY-03T Front & Rear.

Model DHY-03EC Eurocard automatic digital TBU



Figure 1-4 : DHY-03EC View From Above.



Connecting the DHY-03 TBU

Connect the earth and mains power connections as per the information given in the Warranty and Safety Information sections of the handbook. The hybrid unit should be connected with reference to Figure 1-4.

The telephone line socket is connected to the telephone network using the RJ11 to RJ11 cable provided. An adaptor is provided to connect to a standard BT socket.

A simple telephone handset can be used to take and make calls when plugged into the equipment handset connector. An adapter is provided if the handset is fitted with a BT plug as standard.

A remote switch may be connected at the Remotes socket in order to control the line connect button from say, the telco channel of a mixing desk.

Connect the output from the mixing desk "clean-feed" to the mic/line input of the DHY-03, with the mic/line input select switch set to "line". A clean-feed is a signal produced by a telco module on a mixer which is used as the output to be fed back to a caller on a telephone line. The cleanfeed is a sum of all the other signals which constitute the programme output, except for the caller's audio (this is so that the caller doesn't hear him/herself in the ear-piece). A cleanfeed signal will generally be of a better quality than a mix-minus signal.

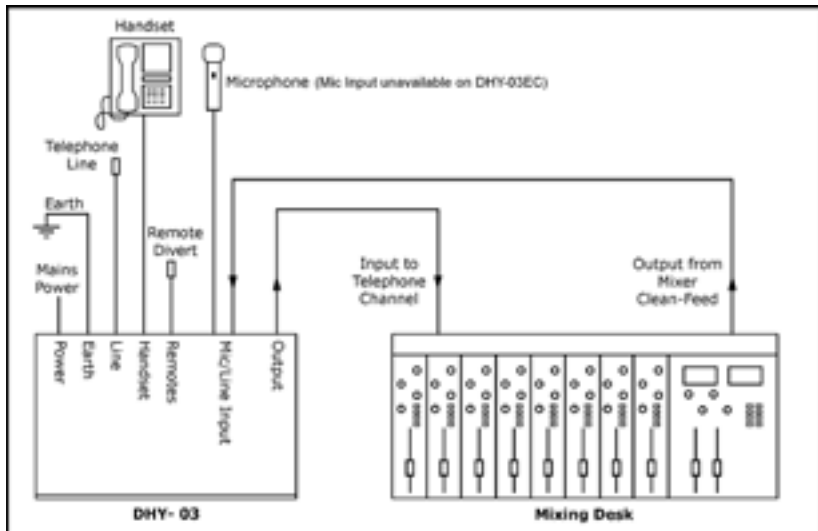

Figure 1-5 : DHY-03 User Connections.

The characteristics of the mic/line input are determined by the state of the mic/line configuration selection switch. It is a balanced bridging input and in line mode will accept normal signals at 0dBu peaking to +8dBu from a sound mixer clean feed. In mic mode, available on all units except DHY-03EC, the unit will accept 200 Ω microphone level signals with a maximum gain of 74dB. It is suitable for a wide range of microphones and the available gain is 74dB to 40dB, which can be adjusted by the mic level pre-set mounted

on the rear panel. The input circuitry to the DHY-03 has a very effective limiter, which will prevent high level overloading problems. Ideally, the maximum input level should not exceed +12dBu. This limiter is used for both line and mic input modes.

Connect the output of the DHY-03 to the tele input of the mixing console. The output connection will deliver a balanced/floating low impedance signal of 0dBm from the telephone line. The output of the digital hybrid unit is normally 0dBu from a balanced source of 50 Ω or less across the useful bandwidth of the equipment. The bandwidth is restricted by the line conditions between 250 Hz and 4 kHz. The output stage is capable of driving into 600 Ω loads at up to +8dBu. Termination of the output is not necessary however and direct connection can be made into the mixer telephone return channel.

The output stage has a 3-way gain switch control, mounted on the front panel (level to line), which may be set to give 0dB signals at the output. In addition an output noise gate operates when the telephone signal is below the noise gate threshold control. This noise gate reduces the output gain by 34dB under no signal conditions eliminating the affects of telephone line cross talk.

Isolation of better than 75dB is created between the input and output connectors when the hybrid unit is functioning on an exchange line.

Note: The earth bond at the screw terminal must be connected to a technical earth to ensure the safe operation of the equipment under all line conditions.

Using the DHY-03

First Use

Before using the DHY-03 you should ensure that it is connected as figure 1-4 and that the unit is setup for the correct line conditions.

1. With the unit powered off set the dipswitches of the SETTINGS on the rear panel to the appropriate country specification (see Table 2-1).
2. Ensure that dipswitch 8 is also set on and then power up the unit. During the power up cycle the new country code should be reflected in the top row of LEDs, on the front panel.
3. Now return the dipswitches to their default condition – switches 1,2 & 6 on, with switches 3 & 4 also on if you wish to use automatic call handling. The unit should now be ready to make & receive calls.

Using the DHY-03 with the Broadcast Bionics PhoneBox

The DHY-03 telephone hybrids can be simply configured to operate with the Avaya telephone switch used in the Broadcast Bionics PhoneBox system. Follow the procedure for "First Use" and in section 1, select Country code number 119 (see page 21). This will configure the hybrid to operate correctly with the Avaya switch.

Using the DHY-03 with Internal Telephone Exchanges

The DHY-03 can be configured to operate with internal exchanges, such as the Avaya exchange - contact technical.support@sonifex.co.uk with details of the exchange and we should be able to program the unit to those particular settings, using one of the User Set country codes (see page 19).



Receiving a Call

With the equipment connected as in Figure 1-4 calls may be received and detected by the ringer in the telephone handset. To receive the call, lift the handset and establish contact with the caller. The call may be diverted to the telephone hybrid by pressing either the front panel mounted line connect button or by means of the remote connect switch (if connected).

Note : The DHY-03EC and later DHY-03 units (see page 40) have an integrated divert relay that will automatically disconnect the handset when the unit handles the calls. For early DHY-03 units (see page 40), at this point, the telephone handset must be replaced, otherwise the line will be double terminated resulting in poorer performance. For early units, order the accessory DHY-03RLY in order to have a divert relay to automatically disconnect the handset.

Alternatively, the incoming calls can be answered manually from the line connect button or the remote line connect switch or automatically by enabling the integrated ringing detector (settings SW4 On). Ringing tone will illuminate the line connect button. The line connect button lamp is off in the non-connected mode and illuminated in the connected mode. It is recommended that the auto-disconnect feature be used when the ringing detector is enabled.

Note : The remote lamp tally mimics the front panel line connect button lamp, i.e. it flashes when ringing and is on when the line is held.

The hybrid unit will now behave as a 4-wire to 2-wire converter with signal inputs at the mic/line input connector and telephone signal output at the output connector.

The call may be cleared by re-pressing the line connect button or by means of the remote divert switch. The call can also be cleared automatically by enabling the auto-disconnect feature, or via the serial port CLR: command

With both auto-answer and auto-disconnect in use, call handling can be completely automatic in operation (settings SW3 & SW4 On).

The DHY-03EC has a on-board line connect switch and LED to indicate it's function. Normally the line connect function is performed through the remote line connect input.

Integrated Ringing Detector – Auto Answer

Ringing detectors can be used when you need to answer a call automatically, for instance, if a journalist files a report to a tape recorder over a telephone line, the call can be picked up after a set number of rings by the ringing detector. The DHY-03 has a built in ring detector that is enabled by setting SW4 on the rear panel.

Making a Call

To initiate a call, lift the handset and dial the required telephone number. When the call has been established, press the line connect button and the call will be handed over to the telephone hybrid unit. At this point, for early DHY-03 units (see page 40) the telephone handset must be replaced, otherwise the line will be double terminated resulting in poorer performance. To clear the line at the end of the call, press the line connect button. The line

connect button lamp is off in the non-connected mode and illuminated in the connected mode. The DHY-03 is also capable of making outgoing calls via DTMF dialling by using the serial port and sending a TEL:nnnnn command.

If the line is not connected to a valid telephone system (determined by no line voltage present) then trying to connect is invalid. Pressing the line hold button will cause it to flash twice quickly. If the attempt to connect is via the serial port then the DHY-03 returns an ERR:08 error message.

Call Established

Level Setting

The DHY-03 hybrid operation is optimised for signals around 0dB. The front panel gain switches can adjust the signal levels for both caller and sender. The default position for these switches is receive gain (upper) fully counter-clockwise (-6dB) and the transmit gain (lower) to be in the middle (0dB). Set the lower switch so that the bargraph normally shows 0dB (second yellow LED) with occasional peak signal levels illuminating showing +6dB (first red LED). If your mixing desk or source audio is only sent at consumer level then JP1 should be fitted (see Figure 2-5 or Figure 2-8).

DTMF Detection

The caller can use this feature in conjunction with auto answer to force external actions from the DHY-03. Once again in the case of journalists ringing in a report, they can press a key on the telephone keypad to switch on an external recorder. The key used is set by parameter 2 (see Parameter Numbers - Function and Value). The presence of the DTMF tones in the incoming signal for the chosen key will activate the output on the remote connector.

Integrated Disconnect Detector – Auto Disconnect

The DHY-03 can detect when a call has been dropped by the caller and can release the line. There are a variety of ways that the central exchange can signal this to remote equipment and the DHY-03 supports the 3 most common methods: –

- Momentarily reversing the polarity of the signal (line reversal);
- Momentarily shorting the tip & ring (K-break)
- Issuing a tone to the line (tone detect).

The method chosen is initially determined by the country code selected, but this can be overridden by changing parameter 25, serially.

Conference Calls

The DHY-03 has the ability to conference 2 calls on separate DHY-03 units together so that you need only use 1 telco module on the mixer. These units are linked by a CAT 5 cable (wired as shown overpage) via the RJ45 connectors on the rear of the units. The conference calls record feature is unavailable on the DHY-03.

Note: This is not a standard CAT 5, or CAT 5 crossover, cable.

Establishing calls on both units will allow each caller to hear a mix of the clean-feed station output and the other caller. The feed to the mixer will contain a mix of both received calls.



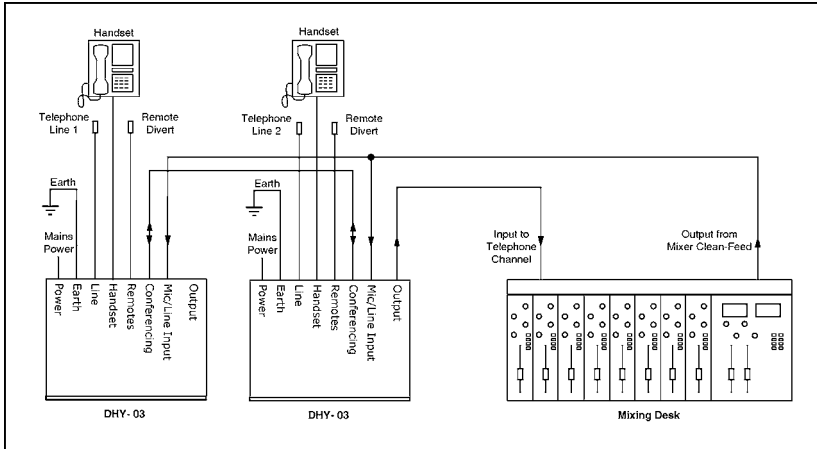

Figure 1-6: Audio Paths for Conference Call.

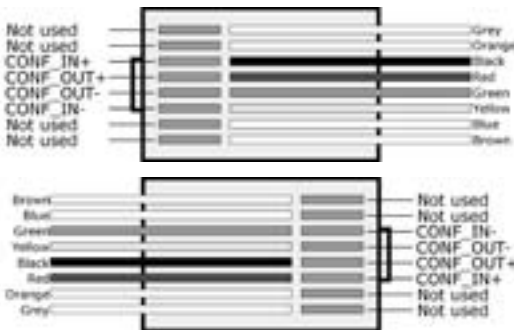

Figure 1-7: Conference Port Cable Connections.

The conference port cable simple cross-connects the Conference Input (Phase and Non-Phase) signals to the Conference Output (Phase and Non-Phase) signals respectively. It is available as an accessory, DHY-03CONF.

Using the Conference Port as a Record Output

If you are not using the conference port, it can be used to provide a balanced audio output from the Conference Output Phase and Non-Phase pins. This output will contain just the caller signal unless JP3 is fitted (see Figure 2-5), which will create a mix of caller and sender on the record output.

2 Configuration & Controls - DHY-03, DHY-03S, DHY-03T

Front Panel Controls

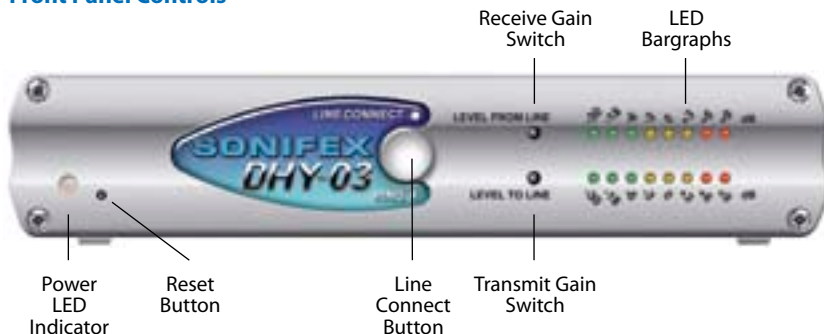

Figure 2-1 : Front Panel Controls.

Power LED Indicator

The power LED indicates that the equipment is powered and operational when illuminated.

Line Connect Button

This is the front panel button used to connect calls to, and disconnect calls from, the telephone line. The switch will illuminate to indicate the call has been connected. The line connect button will flash when an incoming call is detected. Operation of this button can be remotely controlled.

Gain Switches

These switches allow gain/attenuation to be applied to the incoming & outgoing analogue audio. Each switch has 3 positions, rotating the switches clockwise give gains of -6dB, 0dB & +6dB. The normal position for the transmit gain to the telephone line (lower switch) is 0dB and for the receive gain from telephone line (upper switch) is -6dB.

LED Bargraphs

These 8 position bargraphs, by default, indicate the signal levels of the incoming audio signal (lower) and outgoing audio (upper). For best operation set the signal gain switches to achieve all 3 yellow LEDs mostly illuminated with occasional audio peaks lighting the first red LED. The default operation can be changed by setting the Meter Select parameter 7 via the serial port.

The scale indicates from left to right – Green (-30dB, -18dB, -6dB); Yellow (-3dB, 0dB, +3dB); & Red (+6dB, +9db).

Status & Operating Mode Information

The LED display is also used to indicate special operating modes and other settings as follows:

- Alternating 2 LEDs on, 2 LEDs off pattern indicates that the DHY-03 is checking the status of the Line Connect Button to test the Bootstrap Mode (see page 24).
- Alternating 4 LEDs on, 4 LEDs off pattern indicates that the DHY-03 has entered Bootstrap mode, because either the Line Connect Button was held down for ~10 seconds at power up, or the Main code has been corrupted (most likely due to a previous incomplete firmware update).
- Alternating 8 LEDs on, 8 LEDs off pattern indicates that the DHY-03 has received a 'DWN' command from the serial port and is updating the firmware (valid in either Bootstrap or Normal operation).
- On normal power up the top row of LEDs shows the current country selection (see table 2-1 with LEDs numbered from left to right reflecting the dipswitch settings). The bottom row shows a chase pattern of 2 LEDs moving from left to right, followed by the current hybrid pointer parameter value. This value is explained on page 24 and the LEDs will show (from left to right) the Set (1 LED); the Entry in the table (3 LEDs) and the Table (4 LEDs) currently being used.
- If there is a fault during power up, the first and last LEDs on the bottom row will alternately flash and the top row will show:-
 - LED1 (left most LED) indicates UART initialisation fault.
 - LED2 indicates Codec initialisation fault.
 - LED1+2 indicates Silab chipset initialisation fault.
 - LED3 indicates Silab front end failure.
 - LED1+3 indicates Silab telephony failure.
- Once initialisation is complete the LEDs show the Bargraph info as above.
- During Network Hybrid Calibration the bottom row of LEDs shows the current setting of the hybrid select parameter being used.
- When jumper 2 is fitted and the parameter is set to show the system status the following info is indicated on the top row:-
 - LED1 (left most LED) lights to indicate that the network echo cancellation is enabled.
 - LED2 lights to indicate that the acoustic echo cancellation is enabled.
 - LED3 lights to indicate both signals are too high for adaptation.
 - LED4 lights to indicate that the signal is in 'hold off' after last adaptation cycle.
 - LED5 lights to indicate that the signal from the analogue input is above the threshold for adaptation.
 - LED6 lights to indicate that the signal from the telephone line is above the threshold for adaptation.
 - LED7 is unused.
 - LED8 (right most LED) is always lit to indicate status mode.

Reset Button

In the unlikely event that the DHY-03 unit fails to respond, press the reset button to reboot the unit.

Rear Panel Controls

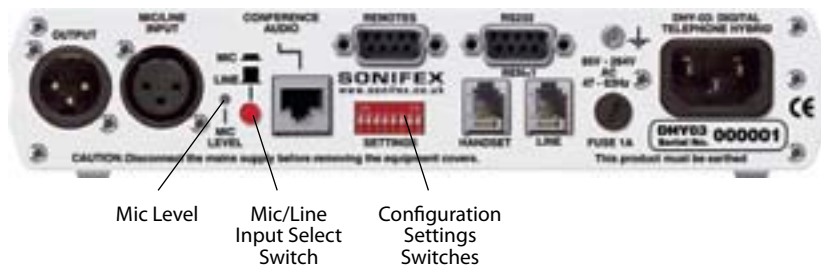

Figure 2-2 : Rear Panel Controls.

Adjusting the Microphone Gain Level

The Mic Level Preset Pot controls the level of the input signal when the input signal mode is set to Mic. The input signal level in Line mode is factory set and is not affected by this control. The Mic Input will accept 200 Ω microphone level signals and is balanced/floating with a maximum gain of 70dB. Use a jeweller's screwdriver to adjust the gain between 70dB and 52dB. The gain range can be extended by ± 6 dB by using the front panel transmit gain switch.

Mic/Line Input Select Switch

This push-button switch sets the input signal mode:

Switch depressed (in) - Mic input mode selected

Switch not depressed (out) - Line input mode selected

Configuration Settings Switches

The SETTINGS switches are used to configure the DHY-03 in the modes that you want it to operate. A label on the top panel of the unit shows the orientation of the switches: The following paragraphs describe the function of each switch; the default or normal position is shown in curly brackets.

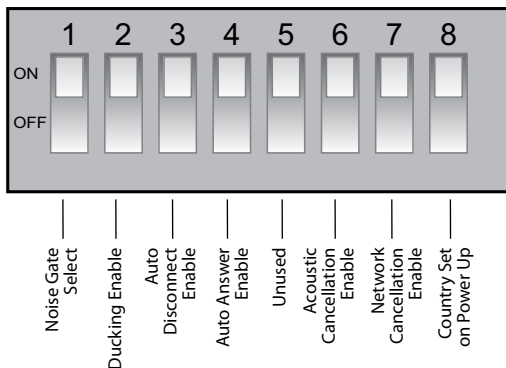

Figure 2-3 : Configuration Settings Switches.

Noise Gate Select - SW1 {ON}

An output noise gate operates when the telephone signal is below the noise gate threshold control. This noise gate reduces the output gain by 34dB during low level signal conditions. This eliminates the effects of telephone line cross talk. The noise gate can be switched off if you don't wish to use it by switching SW1 to the off position.

Ducking Enable - SW2 {ON}

This switch allows the received signal to be automatically attenuated by 18db when both received and sent audio are present in the hybrid. This allows an operator in the studio to talk over the caller at all times.

Auto Disconnect Enable - SW3 {ON}

When SW3 is enabled (ON) the DHY-03 will automatically disconnect from the telephone line by detecting appropriate disconnect regime selected for the specific country according to the selected country code (see Table 2-2). Line reversal and K-break work by changing the voltage on the line and have parameters settings which indicate a duration range for which this voltage change must be present. Tone detection has a more complicated and extensive parameter set. A variety of single or dual tones with level control are available together with the ability to handle cadence patterns, where known countries disconnect requirements are preset, but if not the ETSI default of 400Hz tone is used. These parameters can be defined to use standard tones or the user sets which are set via the serial port. You may need this capability if your telephone system provides non-standard call progress tones.

Ring Detector (Auto Answer) Enable - SW4 {ON}

This switch enables the integrated ring detector, which automatically answers incoming calls after the number of rings set in parameter 5 (see page 26). The default is 3 rings.

Note double cadence ring tones will count both rings in the cadence pattern.

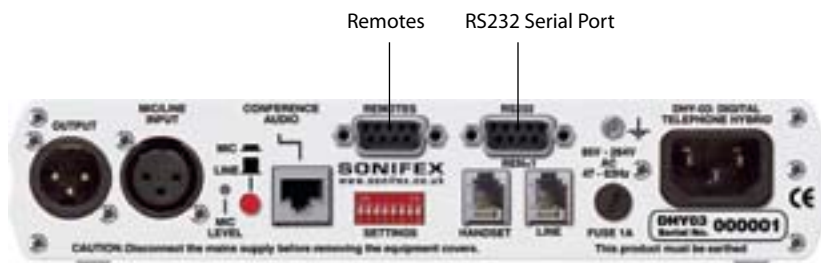

Figure 2-4 : Rear Panel Controls.

Acoustic Cancellation Enable – SW6 {OFF}

When switch SW6 is enabled the DHY-03 performs a local acoustic cancellation on the incoming signal from the audio input. This is required when this signal contains elements of the signal sent to the output (e.g. in a bingo hall when the output goes to the speakers and the input is driven from a microphone that can pick up the speaker output.)

Network Cancellation Enable – SW7 {ON}

When switch SW7 is enabled (on) the DHY-03 will perform the echo cancellation routine on the incoming signal from the telephone line. This would be the normal operational setting, but it may be disabled for special circumstances.

Country Set on Power Up – SW8 {OFF}

SW8 is only read on power-up and needs to be on to set the specific country code to be used for the unit (set on remaining switches - see Table 2-1 on page 19). After power up the switches should be returned to their normal position, otherwise the unit may fail to work correctly. The country code can also be changed via the serial port, but in either case when the country setting is altered, any calibration parameters are discarded as they will most likely now be incorrect. These parameters include tuned hybrid impedance settings & coefficients and default cancellation calculation coefficients.

Remotes

The remote port allows the user to control the line hold circuit from a mixing desk or other remote device and also outputs opto-isolated outputs to indicate the line hold status and the DTMF detect function. See chapter 4 for connection details.

RS232 Serial Port

The serial port allows the user to remote control the DHY-03 connection, including the ability to dial out using Tone Dialling. This port is also used to adjust the operational parameters and upload new firmware. Full details are given in chapter 3.

DHY-03 Internal Controls & Adjustments

If you need to get inside the unit to make configuration adjustments, simply remove the 4 screws in the corners of the rear panel. The rear panel and main PCB will slide backwards out of the metal chassis.

When re-inserting the main PCB, ensure that the PCB edges are in the runners inside the chassis and also that the power LED and line connect button are in the correct place in the front panel.

Warning : The power must be switched off at the supply or the power lead must be disconnected before attempting to open the unit. Removal of the cover can expose dangerous voltages.

Warning : The telephone line plug should be disconnected from the telecommunications network exchange line before removing the cover.

There are 3 jumpers on the main board:

JP1 is used to switch an extra 10dB of audio input gain to allow for use of domestic level mixing desks.

JP2 is user selectable, the function being set via parameter 6 in the serial port interface. It is used mainly for debugging the network cancellation algorithm.

JP3 allows the conferencing port output to be used as a record out by mixing the input and output signals together and routing them to the Conference Output Phase & Non-Phase pins.

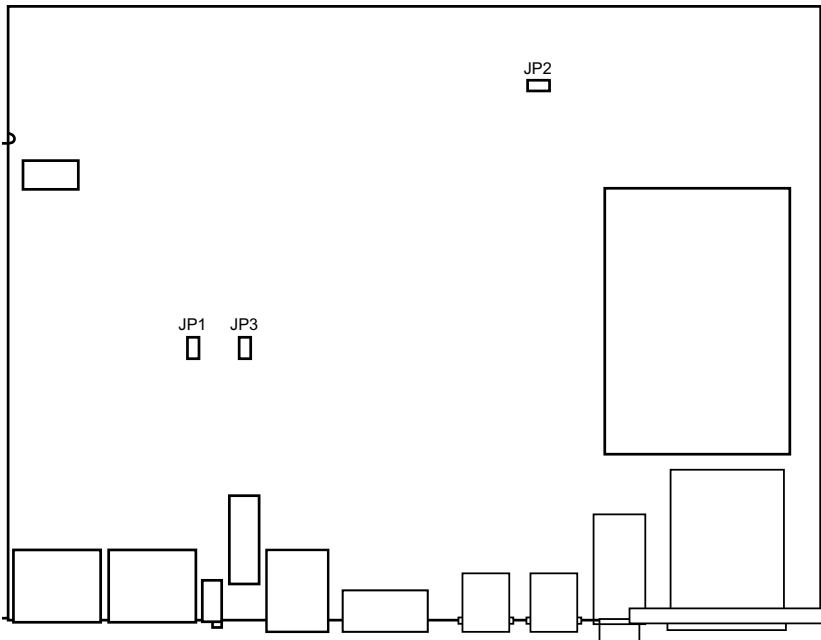

Figure 2-5 : PCB Layout.

Configuration & Controls - DHY-03EC

Controls

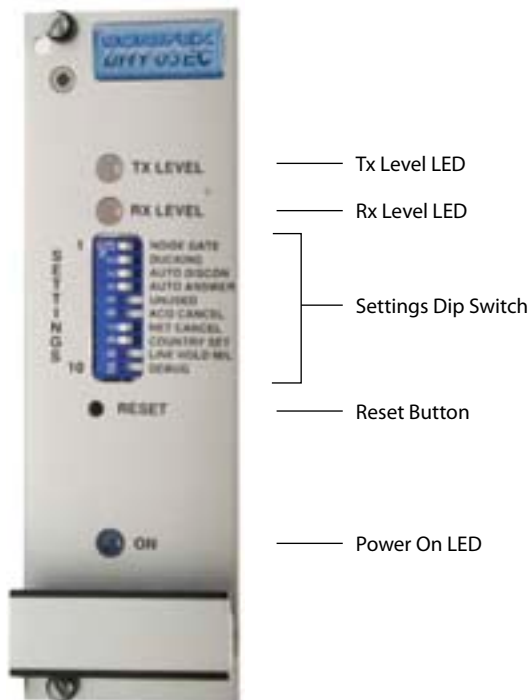

Figure 2-6 : DHY-03EC Controls.

Power LED Indicator

The power LED indicates that the equipment is powered and operational when illuminated.

Gain Jumpers

Refer to Fig 2-8. These jumpers allow gain/attenuation to be applied to the incoming & outgoing analogue audio. Each jumper has 3 positions, jumper 1-2, off and 3 jumper 2-3 that give gains of -6dB, 0dB & +6dB respectively. The normal position for the transmit gain to the telephone line (J3) off) is 0db and for the receive gain from telephone line (J4 1-2) is -6dB.

Tricolour LED Level Indicators

These Tricolour LEDs indicate the signal level of the incoming audio signal (left) and level received from line (right). For best operation set the signal gain switches to achieve LED mostly illuminated yellow with occasional audio peaks lighting the red LED.

The scale indicates – Green (-30dB, to -3dB); Yellow (-3dB, to +6dB); & Red (+6dB, LED).

Status & Operating Mode Information

The Tricolour LEDs are also used to indicate special operating modes and other settings as follows:

- Alternating Rx, Tx Yellow pattern indicates that the DHY-03 is checking the status of the Line Connect Button to test the Bootstrap Mode (see page 24).
- Alternating Rx, Tx Yellow/Rx, Tx off pattern indicates that the DHY-03 has entered Bootstrap mode, because either the Line Connect Button was held down for ~10 seconds at power up, or the Main code has been corrupted (most likely due to a previous incomplete firmware update).
- Alternating Rx Red, Tx Green/Rx Green, Tx Red pattern indicates that the DHY-03 has received a 'DWN' command from the serial port and is updating the firmware (valid in either Bootstrap or Normal operation).
- On normal power up the top row of LEDs shows the current country selection. Count the Tx & Rx flashes and the country code is the sum of Tx multiplied by 16, plus Rx (see Table 2-1)
- If there is a fault during power up, the Tx Red & Rx Red LEDs will flash alternately.
- Once initialisation is complete the LEDs show the level info as above.

Reset Button

In the unlikely event that the DHY-03 unit fails to respond, press the reset button to reboot the unit.

Configuration Settings Switches

The SETTINGS switches are used to configure the DHY-03 in the modes that you want it to operate. A label on the top panel of the unit shows the orientation of the switches: The following paragraphs describe the function of each switch; the default or normal position is shown in curly brackets.

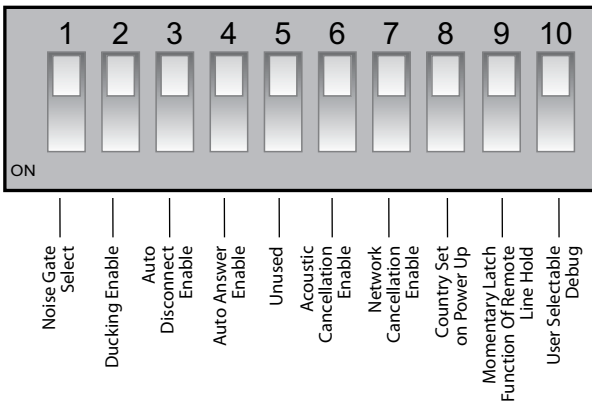

Figure 2-7: DHY-03EC Configuration Settings Switches.

Noise Gate Select - SW1 {ON}

An output noise gate operates when the telephone signal is below the noise gate threshold control. This noise gate reduces the output gain by 34dB during low level signal conditions. This eliminates the effects of telephone line cross talk. The noise gate can be switched off if you don't wish to use it by switching SW1 to the off position.

Ducking Enable - SW2 {ON}

This switch allows the received signal to be automatically attenuated by 18db when both received and sent audio are present in the hybrid. This allows an operator in the studio to talk over the caller at all times.

Auto Disconnect Enable - SW3 {ON}

When SW3 is enabled (ON) the DHY-03 will automatically disconnect from the telephone line by detecting appropriate disconnect regime selected for the specific country according to the selected country code (see Table 2-2). Line reversal and K-break work by changing the voltage on the line and have parameters settings which indicate a duration range for which this voltage change must be present. Tone detection has a more complicated and extensive parameter set. A variety of single or dual tones with level control are available together with the ability to handle cadence patterns, where known countries disconnect requirements are preset, but if not the ETSI default of 400Hz tone is used. These parameters can be defined to use standard tones or the user sets which are set via the serial port. You may need this capability if your telephone system provides non-standard call progress tones.

Ring Detector (Auto Answer) Enable - SW4 {ON}

This switch enables the integrated ring detector, which automatically answers incoming calls after the number of rings set in parameter 5 (see page 26). The default is 3 rings.

Note double cadence ring tones will count both rings in the cadence pattern.

Acoustic Cancellation Enable – SW6 {OFF}

When switch SW6 is enabled the DHY-03 performs a local acoustic cancellation on the incoming signal from the audio input. This is required when this signal contains elements of the signal sent to the output (e.g. in a bingo hall when the output goes to the speakers and the input is driven from a microphone that can pick up the speaker output.)

Network Cancellation Enable – SW7 {ON}

When switch SW7 is enabled (on) the DHY-03 will perform the echo cancellation routine on the incoming signal from the telephone line. This would be the normal operational setting, but it may be disabled for special circumstances.

Country Set on Power Up – SW8 {OFF}

SW8 is only read on power-up and needs to be on to set the specific country code to be used for the unit (set on remaining switches - see Table 2-1 on page 19). After power up the switches should be returned to their normal position, otherwise the unit may fail to work correctly. The country code can also be changed via the serial port, but in either case when the country setting is altered, any calibration parameters are discarded as they will most likely now be incorrect. These parameters include tuned hybrid impedance settings & coefficients and default cancellation calculation coefficients.



Momentary Latching Function - SW9 {OFF}

SW9 changes the function of the Remote Line Connect Switch between Momentary (OFF) and Latching (ON).

Debug Function - SW10 {OFF}

SW10 is used to instigate the Debug Feature set by Parameter 6 in the Serial Port Interface.

Remotes

The remote port allows the user to control the line hold circuit from a mixing desk or other remote device and also outputs opto-isolated outputs to indicate the line hold status and the DTMF detect function. See chapter 4 for connection details.

RS232 Serial Port

The serial port allows the user to remote control the DHY-03 connection, including the ability to dial out using Tone Dialling. This port is also used to adjust the operational parameters and upload new firmware. Full details are given in chapter 3.

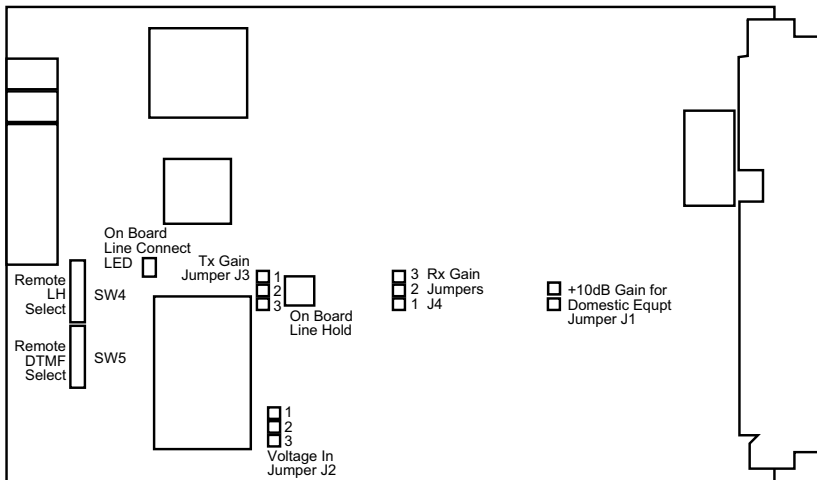

Figure 2-8 : DHY-03EC Diagram.

Jumper and Select Switcher Functions

J1 is used to switch an extra 10dB of audio input gain to allow for use of domestic level mixing desks.

J2 selects incoming DC voltage to $\pm 15V$ (1-2) or $+5V$ (2-3).

J3 + J4 set gains for signal to and from telephone line.

SW4 remote line hold output select.

SW5 Remote DTMF output select.

These switches define the operation of the remote outputs selecting between

Position 1: Output driven to $+5V$.

Position 2: Output driven to $+15V$ (only if $+15V$ supplied to board).

Position 3: Output pulled low.

Country Code Selection

The correct country code selection is essential for proper operation of the DHY-03 unit. It ensures that all telephone approval parameters are met for operation of this unit in various parts of the world. The table below is likely to change - additional countries or PABXs and possible detail changes for existing countries. However the actual country codes are fixed and will not alter. For the latest table please refer to our website www.sonifex.co.uk/dhy03

The country codes are selected on power up, by setting dipswitch 8 of the SETTINGS on the rear panel to the "ON" position and setting switches 1-7 as per the following table. Once the system has initialised – indicated by the chase pattern of LEDs on the lower bargraph, then all switches should be returned to their previous position for the correct operation of the unit. ETSI, the European Telecommunications Standards Institute (<http://www.etsi.org/>) govern the telcoms standards used and in the majority of cases, it has been provisionally assumed that the disconnect tones are at the ETSI standard - Code 1 in the table below.

Country	Code	Disconnect Tone Frequencies	Disconnect Type	Details	Dipswitches set on power up
ETSI – TBR21	1	400Hz	Continuous		1
Argentina	2	400Hz *	Continuous		2
Australia	3	400Hz *	Continuous		1+2
Austria	4	400Hz *	Continuous		3
Bahrain	5	400Hz *	Continuous		1+3
Belgium	6	400Hz *	Continuous		2+3
Brazil	7	400Hz *	Continuous		1+2+3
Bulgaria	8	400Hz *	Continuous		4
Canada	9	400Hz *	Continuous		1+4
Chile	10	400Hz *	Continuous		2+4
China	11	400Hz *	Continuous		1+2+4
Colombia	12	400Hz *	Continuous		3+4
Croatia	13	400Hz *	Continuous		1+3+4
Cyprus	14	400Hz *	Continuous		2+3+4
Czech Republic	15	400Hz *	Continuous		1+2+3+4
Denmark	16	400Hz *	Continuous		5
Ecuador	17	400Hz *	Continuous		1+5
Egypt	18	400Hz *	Continuous		2+5
El Salvador	19	400Hz *	Continuous		1+2+5
Finland	20	400Hz *	Continuous		3+5
France	21	400Hz *	Continuous		1+3+5
Germany	22	400Hz *	Continuous		2+3+5
Greece	23	400Hz *	Continuous		1+2+3+5
Guam	24	400Hz *	Continuous		4+5
Hong Kong	25	400Hz *	Continuous		1+4+5
Hungary	26	400Hz *	Continuous		2+4+5
Iceland	27	400Hz *	Continuous		1+2+4+5
India	28	400Hz *	Continuous		3+4+5
Indonesia	29	400Hz *	Continuous		1+3+4+5



Country	Code	Disconnect Tone Frequencies	Disconnect Type	Details	Dipswitches set on power up
Ireland	30	400Hz *	Continuous		2+3+4+5
Israel	31	400Hz *	Continuous		1+2+3+4+5
Italy	32	400Hz *	Continuous		6
Japan	33		Line Reversal		1+6
Jordan	34	400Hz *	Continuous		2+6
Kazakhstan	35	400Hz *	Continuous		1+2+6
Kuwait	36	400Hz *	Continuous		3+6
Latvia	37	400Hz *	Continuous		1+3+6
Lebanon	38	400Hz *	Continuous		2+3+6
Luxembourg	39	400Hz *	Continuous		1+2+3+6
Macao	40	400Hz *	Continuous		4+6
Malaysia	41	400Hz *	Continuous		1+4+6
Malta	42	400Hz *	Continuous		2+4+6
Mexico	43	400Hz *	Continuous		1+2+4+6
Morocco	44	400Hz *	Continuous		3+4+6
Netherlands	45	400Hz *	Continuous		1+3+4+6
New Zealand	46		Line Reversal		2+3+4+6
Nigeria	47	400Hz *	Continuous		1+2+3+4+6
Norway	48	400Hz *	Continuous		5+6
Oman	49	400Hz *	Continuous		1+5+6
Pakistan	50	400Hz *	Continuous		2+5+6
Peru	51	400Hz *	Continuous		1+2+5+6
Philippines	52	400Hz *	Continuous		3+5+6
Poland	53	400Hz *	Continuous		1+3+5+6
Portugal	54	400Hz *	Continuous		2+3+5+6
Romania	55	400Hz *	Continuous		1+2+3+5+6
Russia	56	400Hz *	Continuous		4+5+6
Saudi Arabia	57	400Hz *	Continuous		1+4+5+6
Singapore	58	400Hz *	Continuous		2+4+5+6
Slovakia	59	400Hz *	Continuous		1+2+4+5+6
Slovenia	60	400Hz *	Continuous		3+4+5+6
South Africa	61	400Hz *	Continuous		1+3+4+5+6
South Korea	62	400Hz *	Continuous		2+3+4+5+6
Spain	63	400Hz *	Continuous		1+2+3+4+5+6
Sweden	64	400Hz *	Continuous		7
Switzerland	65	400Hz *	Continuous		1+7
Syria	66	400Hz *	Continuous		2+7
Taiwan	67	400Hz *	Continuous		1+2+7
TBR21 - ETSI	68	400Hz	Continuous		1 OR 3+7
Thailand	69	400Hz *	Continuous		1+3+7
Turkey	70	400Hz *	Continuous		2+3+7
UAE	71	400Hz *	Continuous		1+2+3+7
United Kingdom I	72	400Hz *	Continuous		4+7

Country	Code	Disconnect Tone Frequencies	Disconnect Type	Details	Dipswitches set on power up
United Kingdom II	73		K-Break		1+4+7
United States I	74	400Hz *	Continuous		2+4+7
United States II	75		Line Reversal		1+2+4+7
United States III	76	440Hz	Continuous		3+4+7
Yemen	77	400Hz *	Continuous		1+3+4+7
Broadcast Bionics Always Connected	118	N/A	Always On		2+3+5+6+7
Broadcast Bionics PhoneBox - Avaya	119	400Hz	Cadence	375ms On 375ms Off	1+2+3+5+6+7
User Set 1	121	400Hz *	Continuous	Default values as ETSI	1+4+5+6+7
User Set 2	122	Set via Serial Port	Set via Serial Port	Default values as ETSI	2+4+5+6+7
User Set 3	123	Set via Serial Port	Set via Serial Port	Default values as ETSI	1+2+4+5+6+7
User Set 4	124	Set via Serial Port	Set via Serial Port	Default values as ETSI	3+4+5+6+7
User Set 5	125	Set via Serial Port	Set via Serial Port	Default values as ETSI	1+3+4+5+6+7
User Set 6	126	Set via Serial Port	Set via Serial Port	Default values as ETSI	2+3+4+5+6+7

Table 2-1 : Supported Disconnect Tone Details by Country.
(* - Provisional Disconnect Tone Setting Uses TBR21 default of 400Hz Continuous)

The unit can be programmed with other settings, so please contact us if you need the settings for a different country to be implemented. In this case, it would be necessary to have a technical specification of the line conditions, an audio recording or a specification of the disconnect tone parameters (tone, line reversal or K-break).

Hybrid Technical Description

The hybrid has to be very flexible to maintain its operation for the many different countries' telephony systems. There are 3 main parts to consider: - the electrical interface; the impedance presented by the central exchange; and the actual echo cancellation techniques and algorithms. The country code presets will use a theoretical optimum set of values for the various internal parameters of the unit. However in practice it may be necessary to tune some of the parameters (described in Chapter 3) to achieve the best possible results.

Electrical Interface

The telephone system is essentially similar from country to country, but there are small yet significant changes around the globe: e.g. max signal levels, line current limits, ringing conditions etc. These values are preset by the country code selection and can be adjusted via the serial port parameters.



Impedance Matching

The line to the central exchange will present certain impedance to the hybrid, which will mean that the echo response to any signal will be modified according to the frequency and level of that signal. By impedance matching the signal we are able to predict, and therefore subtract, a simple estimation of the echoed signal. The AC impedance and DC impedance parameters can also be both set via the serial port parameters.

Echo Cancellation

The echo part of the returned signal can be expressed in terms of delayed sent signal. The hybrid coefficients are a measure of the amount of signal that is expected to be echoed from each delay slot (TAP). There are 2 echo cancellation routines running on this unit. The first is a simple 8 TAP unit running in the telephone interface ICs. It allows the data presented to the DSP to be easily filtered into a signal with caller input and a signal with just sent signal echo. The second filter is a variable length TAP with dynamic adaptation running on the on-board 24bit DSP. The length of this TAP is dependent of the expected delay in any echoes from the central exchange. The default length is 24ms, but the unit is capable of calculating delays up to 127ms.

The adaptation routines constantly adjust the internal DSP coefficients to achieve the best echo cancellation. However the dynamic performance of this algorithm (i.e. the speed that the echo cancellation is optimised) is inversely dependant on the maximum delay (number of TAPs) allowed, so increasing the delay will result in a slightly poorer dynamic performance.

Calibration of DHY-03 Hybrid

Where the dynamic performance or the rejection ratio is poor then the performance of the DHY-03 can be enhanced by tuning the simple hybrid for best response and by making sure that the starting point for the DSP coefficients is optimised, both on the actual line to be used. This calibration is be done by setting bits in the Calibration Register (parameter 4) via the serial port interface.

Calibration Level	Parameter 4	Function
1	1	Calibrates DSP coefficients for faster settling time
2	4	Calibrates Telephone Interface Hybrid coefficients for current AC termination value. DSP coefficient calibration follows
3	8	Calibrates Telephone Interface Hybrid coefficients for all AC termination values. DSP coefficient calibration follows

Table 2-2: Calibration Parameter Settings.

When the DHY-03 has been set to perform a calibration a call must be established on the actual line to be used by the system. Once a call is established then the DHY-03 will allow 10 seconds for the call conditions to stabilise and the caller to mute their handset, so that any signal present on the line is due to echo from the DHY-03 sent signal. The DHY-03 will



internally generate a 31 frequency multi-tone signal to cover the full range of the telephone bandwidth. The echo signal is monitored and the parameter sets with the lowest return signal are saved to the flash memory.

Calibration of Telephone Interface

The telephone interface chipset contains a simple impedance matching a short-term echo cancellation algorithm. The DHY-03 can tune the parameters for these routines at 2 levels:

- full calibration involves checking the return signal for all possible values of AC impedance and for all sets of the hybrid parameters; local calibration doesn't change the AC impedance and just checks the return signal for the associated set of hybrid parameters. Calibrating the telephone interface parameters will make the current network coefficients invalid so the DHY-03 will perform a network cancellation coefficients calibration.

Calibration of Network Cancellation Coefficients

The DHY-03 will generate a 31 frequency multi-tone signal to cover the full range of the telephone bandwidth and this will be sent to the line in a 2 second on, ½ second off cadence. The full network cancellation algorithm will run to determine the optimum coefficients and these will be saved to flash memory and be used as the starting point whenever the DHY-03 is powered up. These coefficients are only valid for the conditions present during the calibration and will be cleared if the country code or network cancellation duration is changed.

Acoustic Cancellation

In addition to echo cancellation across the network the DHY-03 is able to perform local acoustic echo cancellation. This is used when there is feedback from the audio output to the audio input usually due to the output being sent to speakers and being picked up by a microphone input. The effect of this is that callers will hear themselves in echo and could make a conversation untenable. The DHY-03 is able to perform an echo cancellation algorithm on the return signal and subtract the content due to the original caller from the signal sent to the line. This algorithm has a fixed TAP duration of 16ms and due to the variable nature of the echo is optimised for a softer dynamic response.

Updating Firmware

The DHY-03 operating software is stored in flash memory and can be overwritten as new code is published. The flash memory is partitioned into boot code, firmware, and saved parameters. Only the firmware partitions are erased so that even in the unlikely occurrence of a power fail during the flash update the system can still be recovered. The preferable method of communicating with the DHY-03 is to use the SCI utility provided free from our web site. However it is possible to use Hyperterminal – the standard windows communication package. Set the comms port to 19200, e, 8, 1 with Xon/Xoff protocol and start the DHY-03 in bootstrap mode by powering up with the line connect Button held down for 10 seconds. Once the communication link has been established send a DWN: command and then use the Transfer->Send Text File to send the new bootstrap code. The DHY-03 will reboot when the file transfer is complete.



3 Serial Port Control

DHY-03 Serial Connection

Default connection is 19200, e, 8, 1 and using XON/XOFF handshaking. There are 3 modes of operation for the serial port –

Normal Mode allows the user to monitor & control the DHY-03.

Setting Mode allows the user to change the operating parameters; generate a default set of cancellation coefficients; search for the best line impedance matching characteristic; and update the firmware of the DHY-03 hybrid. In setting mode no call control is available.

Bootstrap Mode is entered by default when the flash memory doesn't contain valid firmware (e.g. when a firmware update has been interrupted) or can be forced by powering up the DHY-03 whilst holding the front panel Line Connect Button on for 10 seconds.

SCI Software

Sonifex provide free of charge software, SCI, to allow the user to manage connection and control of all aspects of the serial port interface: - go to www.sonifex.co.uk/sci for the latest version.

The telephone interface parameters are accessible from the serial port for changing the settings for use on non-standard telephone systems or PABXs and would not normally need to be changed on standard systems. Many of these parameters are critical to the correct operation of the DHY-03. Changing them may impact on the correct working of the unit or cause the unit to operate in a way that is outside the telecom approval regimes. Our advice is that the telephone interface parameters should not be changed without detailed technical knowledge or input from Sonifex. Both country code and disconnect type tables have reserved entries for future additions, if you have special requirements for either of these parameters please contact us with details and we can assess the demand and then add to the standard list as required.

Serial Interface Commands & Responses

Normal Mode Commands

ANS:	- Answer Call	- ACK: or NAK:
Bnn:	- Baud Rate nn=11 (115200) nn=57 (57600) nn=38 (38400) nn=19 (19200) nn=96 (9600)	- ACK: or NAK: (at old rate)
BSV:	- BootStrap version	- BOOT:x.xx
CLR:	- Clear Call	- ACK: or NAK:
RST:	- Reset Serial Port	- _OK_
SER:	- Serial Num request	- SER:xxxxx
SET:	- Enter Settings Mode	- ACK: or NAK:
SRQ:	- Status Request	- SRQ:nn where nn is state of DHY-03

TEL:nnnnn	- Make Call	- ACK: or NAK: where nnnnn is tel number string
UID:	- Unit ID request	- UID:DHY-03 or UID: DHY-03EC
VER:	- version request	- VER:xx_rr where rr indicates the chip revision (only valid for v1.40 & later)

Setting Mode Commands

DWN:	- Download new code	- ACK: or NAK: wait for ACK then send S-records followed by S-record terminator to force programming of flash memory and reboot
ESC:	- Quit without saving changes (causes reboot)	
RDC:	- Read Network Cancellation Coefficients	- ACK: or ERR: - ACK: is followed by complete set of 3byte coefficients
RDP:ppp	- Read Parameters	- ppp:hfff where ppp = param number and hfff is hex value followed by CRLF, if ppp is blank or zero returns all parameters
RET:	- Return to normal mode	
RUN:n	- Read User Name from User n Params	- UNn:ssss or ERR: where n = 1-6 and ssss is zero terminated string
SAV:n	- Initialise User n data to Current Settings of TI data	- ACK: or ERR:
WRC:	- Write Network Cancellation Coefficients	- ACK: or ERR: - ACK: should be followed by 3byte coefficients with EOD: to finish
WRP: ppp=hfff	- Write Parameter	- ACK: or ERR: where ppp = param number and hfff is hex value followed by CRLF
WUN:n:ssss	- Write User Name to User n where n = 1-6 and ssss is zero terminated string	- ACK: or ERR:

Bootstrap Mode Commands

DWN:	- Download new code	- ACK: or NAK: wait for ACK: then send S-records followed by S-record terminator to force programming of flash memory and reboot
SRQ:	- Status Request	- STA:nn where nn is state of DHY-03
UID:	- Unit ID request	- UID:DHY-03 or UID: DHY-03EC
VER:	- version request	- BOOT:xx

Status Request Responses

STA:01	- Initialisation
STA:02	- On Hook
STA:03	- Ringing
STA:04	- Off Hook - connected to line
STA:05	- Setting Mode
STA:06	- Updating Code
STA:80	- Bootstrap Mode

Error Messages

ERR:01	- Command Not Found
ERR:02	- Invalid Command
ERR:03	- Setting Command not in Setting Mode
ERR:04	- Parameter out of range
ERR:05	- Write Parameter is Read Only
ERR:08	- No Line Volts present

DHY-03 Serial Parameters

Parameters are read and written using the RDP and WRP commands in setting mode only

Note: parameter values are described below using decimal values but are sent and received in Hex.

Parameter Numbers – Function and Value

01 – Country Code	(1 – 120 are presets, 121 – 126 are user sets see Table 2-1)
02 – DTMF Select	(0=Off, 1-16=123A456B789C*0#D, 17= Line Connect) and add 128 for divert relay enable
03 – Network Cancellation Duration	in milliseconds – default 24 (Min 10, Max 127)
04 – Calibration Register	(network cancellation coefficients - 1 save next; user hybrid coefficients - 4 tune using current table, 8 tune using all tables)
05 – Auto Answer Rings	(0=Off, 1-10= Number of rings before answering) - Overridden by dip switch SW4
06 – Jumper Function	- Sum of following values sets JP2/Dip Switch 10 jumper function or dipswitch 10 for the DHY-03EC
Network Audio Loop back	= 1 }
Network Audio Multitone	= 2 } Mutually Exclusive options
Network Audio Direct from Line	= 3 }
Line Audio Loop back	= 4 }
Line Audio Estimation Error	= 8 } Mutually Exclusive options
Line Audio Direct from Network	= 12 }
Switch Off Network Adaptation	= 16
Switch Off Acoustic Adaptation	= 32
Top Row LEDs shows Debug Status	= 64
Reserved	= 128
07 – Meter Select – allows user to alter LED bargraph function	
08 – 24 – Reserved	

Parameters 25-49 are for Current Telephone Interface (TI) Settings

- 25 – Current TI Settings – Disconnect Type (see Table 3-1)
- 26 – Current TI Settings – Hybrid Select Register
- 27 – Current TI Settings – Line Out Overload (log scale 32 = 6dB)
- 28 – Current TI Settings – Telephone Interface Register 16
- 29 – Current TI Settings – Telephone Interface Register 17
- 30 – Current TI Settings – Telephone Interface Register 18
- 31 – Current TI Settings – Telephone Interface Register 22
- 32 – Current TI Settings – Telephone Interface Register 23
- 33 – Current TI Settings – Telephone Interface Register 24
- 34 – Current TI Settings – Telephone Interface Register 26
- 35 – Current TI Settings – Telephone Interface Register 30
- 36 – Current TI Settings – Telephone Interface Register 31
- 37 – Current TI Settings – Telephone Interface Register 59
- 38 – Current TI Settings – Disconnect Min (Line reversal or K-break - minimum time present in 8ms units, 0=unused)
- 39 – Current TI Settings – Disconnect Max (Line reversal or K-break - maximum time present in 8ms units, 0=unused)
- 40 – Current TI Settings – Telephone Gain In (+12 to -15 db -> Default -5)
- 41 – Current TI Settings – Telephone Gain Out (+12 to -15 db -> Default -1)
- 42 – Current TI Settings – Telephone Overload (log scale (32=6db) max output value to stop over-hitting network)
- 43 – Current TI Settings – Adaptation Differential
- 44 – Current TI Settings – Adaptation Response
- 45-49 – Current TI Settings – 5 Reserved Parameters

Similarly to Current Telephone Interface Settings

- User1 Telephone Interface Parameters are 50-74
- User2 Telephone Interface Parameters are 75-99
- User3 Telephone Interface Parameters are 100-124
- User4 Telephone Interface Parameters are 125-149
- User5 Telephone Interface Parameters are 150-174
- User6 Telephone Interface Parameters are 175-199





Parameters 200-207 are for User1 Disconnect Tone Settings

200 – User1 DT Settings – Disconnect Tones	(see Table 3-18) – for indication only, actual values set below
201 – User1 DT Settings – Cadence Pattern 1	(0 = no cadence or hi byte = on time & lo byte = off time)
202 – User1 DT Settings – SuccessTime/ Cadence Pattern 2	(time in 8ms units – 2 parameters allow for double patterns)
203 – User1 DT Settings – Cycles for Transform	(no. of cycles plus coefficients defines tone tested)
204 – User1 DT Settings – Coefficient for Tone 1	(single test tone)
205 – User1 DT Settings – Coefficient for Tone 2	(dual test tone)
206 – User1 DT Settings – Threshold Level	(minimum acceptable signal level)
207 – User1 DT Settings – Reserved	

Similarly to User1 Disconnect Tone Settings

User2 Disconnect Tone Parameters are 208-215
User3 Disconnect Tone Parameters are 216-223
User4 Disconnect Tone Parameters are 224-231
User5 Disconnect Tone Parameters are 232-239
User6 Disconnect Tone Parameters are 240-247

Extended Parameter Description

Calibration Register – parameter 3

This register is used to perform the calibration cycle described in page 18.

The settings are as follows :

Calibrate & Save Network Cancellation Coefficients	= 1
Calibrate Telephone Interface Hybrid Coefficients without changing AC Termination	= 4
Calibrate Telephone Interface Hybrid Coefficients changing AC Termination	= 8

Changing the telephone interface hybrid coefficients will cause the network cancellation coefficients to be incorrect so will force a calibrate & save of the network coefficients once the hybrid values are set.

Telephone Interface Meter Select – parameters 7

Allows user to set the function of the bargraph meters and is sum of values selected for the top row, bottom row and debug status (selected via parameter 6 and jumper JP2 or dipswitch 10).

	Network Received	Network Transmit	Line Input	Line Output	Cancellation Status	Cadence Status
Top Row	0	1	2	3*		
Bottom Row	0	4	8*	12		
Debug Status	0	16	32	48	64*	80

Table 3-1 : Meter Select Parameter Values.

* = default value and set value for firmware versions before v1.40

Disconnect Type – parameters 25,50,75,100,125,150,175

Simple	Single Tone	Dual Tone	Cadence Patterns	User Tones
Manual Only 0	350Hz 64	350&400Hz 74	India Dial Tone 94	User Set 1 114
K-break 1	400Hz 65	350&440Hz 75	Bulgaria DT 95	User Set 2 115
Line Reversal 2	425Hz 66	350&450Hz 76	Italy Dial Tone 96	User Set 3 116
Permanent 3	440Hz 67	350&450Hz 77	UK Dial Tone 97	User Set 4 117
Reserved 4	450Hz 68	350&480Hz 78	Avaya Disconnect 98	User Set 5 118
Range 63	480Hz 69		NZ 400Hz Dial 99	User Set 6 119
	620Hz 70	Reserved 79	NZ 900Hz Dial 100	
	900Hz 71	Range 93	Reserved	
	Reserved 72		Range 101-113	
	Reserved 73			

Table 3-2: Disconnect Type Parameter Values.

Telephone Interface Hybrid Pointer – parameters 26,51,76,101,126,151,176

This parameter allows the user to manually choose the set of telephone interface hybrid coefficients to be used. There are 15 tables of entries (0-14), 1 for each ACIM setting with the global compromise setting using the same table as ACIM=2. For each table there are 8 different entries (0-7) that allow for slight variation in the AC impedance presented by the central exchange, and finally for each entry there are 2 sets of coefficients optimised for absolute rejection (set=0) or for least mean square rejection (set=1). The value entered should be the table of entries required x8 (equivalent to ACIM except ACIM=15 use Table=2), plus the entry required x2, plus the set number.

Telephone Interface Register 16 – parameters 28,53,78,103,128,153,178

Name	OHS	IIRE	RZ	RT
Function	On Hook Speed	Transmit & Receive Filter type	Ringer Impedance	Ring Threshold
Value	64 = slow (Australia)	16 – IIR	2 = synthetic	1 = high

Table 3-3: Telephone Interface Register 16.
(Use sum of required values)**Telephone Interface Register 17 – parameters 29,54,79,104,129,154,179**

Name	CALZ	MCAL	CALD	OPE
Function	ADC Calibration	Manual ADC Calibration	Auto ADC Calibration	Overload Protect
Value	128 = Clear Data	64 = Initiate Calibration	32 = Disable	8 = Enable

Table 3-4: Telephone Interface Register 17.
(Use sum of required values)

Telephone Interface Register 18 - parameters 30,55,80,105,130,155,180

Name	RFWE (RNGV=0)	RFWE (RNGV=1)
Function	Ring Detector Full Wave Rectifier	Ring Detector One shot/Envelope
Value	2=Full Wave	2=One Shot

Table 3-5: Telephone Interface Register 18.
(Use sum of required values)

Telephone Interface Register 22 - parameters 31,56,81,106,131,156,181

Name	RDLY1	RDLY0	RMX
Function	Ring Delay Bits 0 & 1 in 256ms steps (add value in RDLY2 for total)		Ring Assertion Max Count
Value	0 = 0 ms; 64 = 256ms; 128 = 512ms; 192 = 768ms		0-63 in 2ms units (0-126 ms)

Table 3-6: Telephone Interface Register 22.
(Use sum of required values)

Telephone Interface Register 23 - parameters 32,57,82,107,132,157,182

Name	RDLY2	MRTO	RCC
Function	Ring Delay Bit 2	Ring Timeout	Ring Confirmation Count Time
Value	128 = 1024ms	See Table	See Table

Table 3-7: Telephone Interface Register 23.
(Use sum of required values).

RTO Value in Reg 23	0	8	16	24	32	40	48	56
Timeout in ms	80	128	256	384	512	640	768	896

RTO Value in Reg 23	64	72	80	88	96	104	112	120
Timeout in ms	1024	1152	1280	1408	1536	1664	1792	1920

Table 3-8: Telephone Interface Register 23 - RTO Values.

RCC Value in Reg 23	0	1	2	3	4	5	6	7
Timeout in ms	100	150	200	256	384	512	640	1024

Table 3-9: Telephone Interface Register 23 – RCC Values.

Telephone Interface Register 24 - parameters 33,58,83,108,133,158,183

Name	RNGV	RAS
Function	Ring Validation	Ring Assertion Time
Value	128 = Enabled	0-63 in 2ms units (0-126 ms)

Table 3-10 : Telephone Interface Register 24.
(Use sum of required values)

Telephone Interface Register 26 - parameters 34,59,84,109,134,159,184

Name	DCV	MINI	ILIM	DCR
Function	Tip Ring DC Voltage	Minimum Operational Loop Current	Current Limiting	DC Impedance (50/800 Ω)
Value	0=3.1V; 64=3.2V; 128=3.35V; 192=3.5V	0=10mA; 16=12mA; 32=14mA; 48=16mA	2=Enabled (60mA)	1=800 Ω

Table 3-11 : Telephone Interface Register 26.
(Use sum of required values)

Telephone Interface Register 30 - parameters 35,60,85,110,135,160,185

Name	FULL2	ACIM
Function	Enhanced Full Scale (x2)	AC Impedance
Value	16 = 2 x Full Scale Tx/Rx	See Table 4-12

Table 3-12 : Telephone Interface Register 30.
(Use sum of required values)





AC Impedance Setting

ACIM Value	Simple Resistance	Series Complex Impedance
0	600 Ω	
1	900 Ω	
2	270 Ω	750 Ω 150 nF
2	275 Ω	780 Ω 150 nF
3	220 Ω	820 Ω 120 nF
3	220 Ω	820 Ω 115 nF
4	370 Ω	620 Ω 310 nF
5	320 Ω	1050 Ω 230 nF
6	370 Ω	820 Ω 110 nF
7	275 Ω	780 Ω 115 nF
8	120 Ω	820 Ω 110 nF
9	350 Ω	1000 Ω 210 nF
10	200 Ω	680 Ω 100 nF
11	600 Ω	2.16 μF
12	900 Ω	1 μF
13	900 Ω	2.16 μF
14	600 Ω	1 μF
15	Global Compromise Impedance Setting	

Table 3-13 : Telephone Interface Register 30 - AC Impedance settings.

Telephone Interface Register 31 - parameters 36,61,86,111,136,161,186

Name	FULL	FOH	OHS2	FILT	LVFD
Function	Full Scale Mode	Fast Off Hook	On Hook Speed2	-3dBFS Filter Pole Select	Line Voltage Force Disable
Value	128=Full Scale Mode	0=512ms; 32=128ms; 64=64ms; 96=8ms	0=<0.5ms; 8=3ms	0= @ 5Hz; 2= @ 200Hz	1=Disable auto switch of Line Voltage to 0v at Low Voltages

Table 3-14 : Telephone Interface Register 31.
(Use sum of required values)

Telephone Interface Register 59 - parameters 37,62,87,112,137,162,187

Name	SQ1 & SQ0	RG1	GCE
Function	Spark Quenching	Receive Gain 1	Guarded Clear Enable
Value	0 = Normal; 80=Australian Spec.	4=Add 1dB Gain to Hybrid	2=Telephone Interface Draws 2.5mA

Table 3-15 : Telephone Interface Register 59.
(Use sum of required values)

Telephone Interface Adaptation Differential – parameters 43,68,93,118,143,168,193

This parameter sets the minimum difference between the line input signal and the network received signal for which recalculation of the network cancellation coefficients will take place (ie adaptation is allowed). This differential can be expressed either as an absolute value or as a proportion of the line input signal.

Absolute Difference	1.5dB	3dB	4.5dB	6dB	7.5dB	9dB
Parameter Value	8	16	24*	32	40	48

Proportional Difference	6.25%	12.5%	18.75%	25%	31.25%	37.5%	43.75%	50%
Parameter Value	129	130	131	132	133	134	135	136

Table 3-16 : Adaptation Differential Parameter Values.

* = default value and set value for firmware versions before v1.40

Telephone Interface Adaptation Response – parameters 44,69,94,119,144,169,194

This parameter sets the response of the adaptation routine and is expressed as a proportion of the maximum value (100%).

Percentage	12.5%	25%	37.5%	50%	62.5%	75%	87.5%	100%
Parameter Value	1	2	3	4	5	6	7	8*

Table 3-17 : Adaptation Response Parameter Values.

* = default value and set value for firmware versions before v1.40

Disconnect Tones – parameters 200,208,216,224,232,240

This value is an indication of the disconnect tone parameters – the tone frequencies and cadence are only set by changing the parameters below.

Tone Frequency	Value	Type of Tone	Value
350Hz	1	Cadence	16384
400Hz	2	Continuous	32768
425Hz	4		
440Hz	8		
450Hz	16		
480Hz	32		
620Hz	64		
900Hz	128		
User Frequency	8192		

Table 3-18 : Table of Disconnect Tone Values.
(Use sum of required values)

Cadence Pattern 1 – parameters 201,209,217,225,233,241

This parameter is set to define a cadence pattern (set to 0 if none). The On time is set in 8ms steps (i.e. 80ms on time is 10steps) this value is multiplied by 256 and added to the off time. The off time is also in set in 8ms steps so a cadence pattern of 80ms on and 120ms off is $10 \times 256 + 15 = 2575$.

Success Time/Cadence Pattern 2 – parameters 202,210,218,226,234,242

If cadence pattern 1 is zero (i.e. cadence patterns are not set) then this parameter determines the no of successive tone tests that need to detect the tone before disconnecting the call. Multiply this value by the number of cycles and divide by 8 for the time in milliseconds for which the tone must be present before disconnecting.

When cadence pattern is non-zero then this parameter is set in the same way as cadence pattern 1 above. It is only used when there is a double pattern in the signal cadence.

Cycles for Transform – parameters 203,211,219,227,235,243

Together with the coefficients below this parameter is the number of cycles required by the DSP to detect the tone(s) accurately. The number is dependant on the tone or combinations of tones used.

Coefficient for Tone 1 – parameters 204,212,220,228,236,244

This parameter sets the coefficient for the tone detection algorithm.

Coefficient for Tone 2 – parameters 205,213,221,229,237,245

This parameter sets the coefficient for the second tone detection algorithm; if only single tone detection is required then this parameter should be set to zero.

Threshold Level – parameters 206,214,222,230,238,246

This parameter sets the acceptable level that a tone must be present for successful detection of that tone to be indicated.

4 Technical Specification

DHY-03 Connection Details

All of the connections are located on the rear of the DHY-03 :

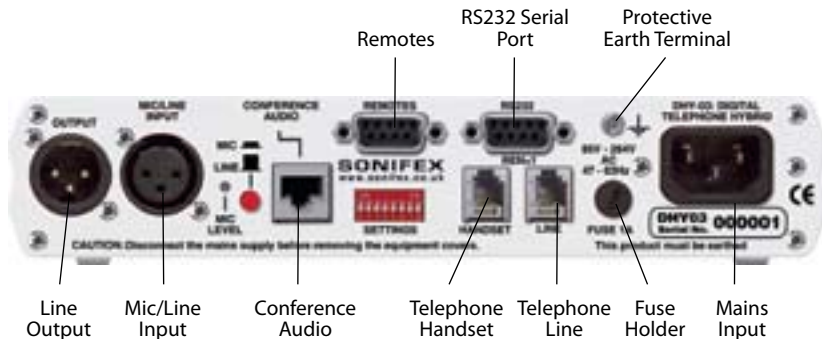
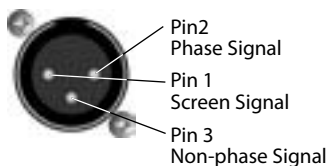

Figure 4-1 : DHY-03 Rear Panel Connections.

Line Output

The line output is an XLR 3 pin male connector (XLR-3-32, 50 Ω balanced floating).

- Pin 1 : Screen
- Pin 2 : Phase
- Pin 3 : Non-phase



Mic/Line Input

The line input is an XLR 3 pin female connector (XLR-3-31, 10k Ω balanced floating).

- Pin 1 : Screen
- Pin 2 : Phase
- Pin 3 : Non-phase

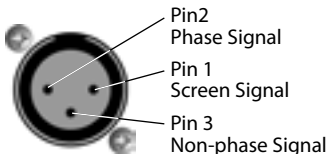

TECHNICAL SPECIFICATION

Remotes

The remote connector is a 9-way female (socket) 'D' type. To remotely line connect, connect pin 1 to pin 2. The action of this remote can act as momentary or latching by pin 6 having no connection or connecting to 0v respectively.

Pins 3 & 7 is an opto-isolated remote line connect indicator and pins 5 & 7 is an opto-isolated DTMF detect output. They can utilise the local supply pins 4 & 8 to drive an LED indicator or a low current load.

Pin 1 : Remote Line Connect Switch

Pin 2 : Common – 0V

Pin 3 : Opto-isolated Line Connect Indicator NPN emitter

Pin 4 : Common – 0V

Pin 5 : Opto-isolated DTMF Detect Indicator NPN emitter

Pin 6 : Momentary/Latch Divert switch action (connect to 0v for latching action)

Pin 7 : Opto-isolated Line Connect Indicator NPN collector

Pin 8 : 5volts out (current limited supply for pins 7 & 9)

Pin 9 : Opto isolated DTMF Detect Indicator NPN collector

Pin 5 **Female** Pin 1

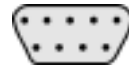

Pin 9 Pin 6

The remote line connect indicator mimics the front panel line connect button lamp, i.e. it flashes when ringing and is on when the line is held.

RS232 Serial Port

The serial port allows direct connection to a 9 way 'D' type connector on a PC via a pin to pin cable. See chapter 3 for details about this interface.

Pin 1 : N/C

Pin 2 : TxD

Pin 3 : RxD

Pin 4 : N/C

Pin 5 : Ground

Pin 6 : N/C

Pin 7 : CTS

Pin 8 : RTS

Pin 9 : N/C

Pin 5 **Female** Pin 1



Pin 9 Pin 6

Telephone Handset

This is the connection for a telephone handset and is an RJ11 6/4 socket. There is a converter lead supplied with the DHY-03 for accepting a standard BT605A telephone plug. The connection details are the same as for the Telephone Line connector.

Telephone Line

This is the telephone line connection and is an RJ11 6/4 socket. Two cables are supplied with the unit, to connect this either to a UK BT line jack socket, or an RJ11 socket. The telephone line is connected via the white and red wires on the connector (on a BT plug, the latch is adjacent to Pin 6).

Telephone Connections

- Pin 1 : N/C
- Pin 2 : Earth recall
- Pin 3 : Telephone line A
- Pin 4 : Telephone line B
- Pin 5 : Ringer
- Pin 6 : N/C



Pin 6 Pin 1

Note: When not used in the UK, connect pins 3 and 4 only for operation.

Conference Audio/Record Output

This is an RJ45 analog audio connector to cross connect to another DHY-03. This will allow a single TBU channel on a mixing desk to handle 2 calls, one to each DHY-03. Alternatively the conference output signals can be used as a record output by fitting the JP3 jumper on the main PCB. The output is then a sum of the caller and main audio input so both sides of the conversation can be recorded from this output.

- Pin 1 : N/C
- Pin 2 : N/C
- Pin 3 : Conference Input (phase)
- Pin 4 : Conference or Record Output (phase)
- Pin 5 : Conference or Record Output (non-phase)
- Pin 6 : Conference Input (non-phase)
- Pin 7 : N/C
- Pin 8 : N/C



Pin 1 Pin 8

Mains Input

The power supply is connected via a filtered IEC Connector and is continuously rated 85-264V AC @ 47-63Hz

Protective Earth Terminal

This earth bond screw terminal is a screen terminal that must be connected to an earth point.

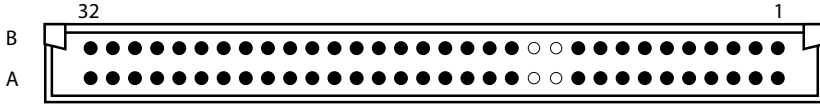

DHY-03EC I/O Connector

Note: All pins used on existing DHY-02EC units have been kept at the same location on the DHY-03EC, so this unit can be fitted directly to an existing installation provided that no unused pins have been used for other purposes.

Row A

Pin 2	:	Telephone Line 1 (Tip)
Pin 4	:	Telephone Line 1 (Ring)
Pin 5	:	Earth Recall
Pin 6	:	Ringer
Pin 7	:	Handset Ring
Pin 8	:	Handset Earth Recall
Pin 9	:	Handset Ring
Pin 10	:	Handset Tip
Pins 11+12:	:	Removed
Pin 16	:	Line Input (phase)
Pin 17	:	Line Input (non-phase)
Pin 18	:	On (screen)
Pin 19	:	Remote DTMF Output (voltage set by switch 5)
Pin 20	:	Line Output (phase)
Pin 21	:	Line Output (non-phase)
Pin 22	:	0V (screen)
Pin 24	:	+15V
Pin 25	:	+5V
Pin 26	:	-15V
Pin 27	:	0V
Pins 28+29:	:	Earth
Pin 30	:	Remote Line Connect Switch (connect to or activate)
Pin 31	:	Remote Line Connect/Ring Indicator (voltage set by switch 4)
Pin 32	:	0V

Row B

Pin 18	:	0V
Pin 22	:	0V
Pin 24	:	+15V
Pin 25	:	+5V
Pin 26	:	-15V
Pin 27	:	0V
Pin 28	:	Serial Port TxD (data out) - Pin 2 on 9 Way D Type
Pin 29	:	Serial Port CTS (handshare in) - Pin 7 on 9 Way D Type
Pin 30	:	Serial Port RxD (data in) - Pin 3 on 9 Way D Type
Pin 31	:	Serial Port RTS (handshare out) - Pin 8 on 9 Way D Type
Pin 32	:	0V (serial ground) - Pin 5 on 9 Way D Type

Technical Specification

Feature	Value
Input Impedance – Line Mode (Clean Feed)	>10k Ω balanced 0dB, optimum working input level 0 to +8dBu
Input Impedance – Microphone Mode	200 Ω balanced
Clean Feed Limiting Input	+4dBu
Microphone Level Range	-70dB to -52dB adjusted by preset pot & \pm 6dB from gain switch
Bandwidth to Telephone Line	125Hz – 3.6kHz, -3dB ref 1kHz
Telephone Line Impedance	Nominally 600 Ω - complex impedances set via country code
Telephone Line Impedance Range	300 Ω to 1500 Ω
Output Impedance	50 Ω balanced floating 0dBu
Output Level Range	\pm 6dB from receive gain switch
Rejection Ratio	78dB on 1kHz tone, typically 75dB on complex waveforms, reference peak level of 0dB
Ring Detector Sensitivity	1 ring to 10 rings
Power	Filtered IEC, continuously rated 85-264V AC @ 47-63Hz, max 10W
Power to DHY-03EC	\pm 15 V DC @ 160mA per rail or regulated +5 V DC @ 600mA

Table 4-1 : Technical Specification.

Physical Specification

Order Code	Description	Height	Width	Depth	Total Nett Weight	Total Gross Weight
DHY-03	Automatic digital TBU with ringing detector, free standing	4.5cm	21.8cm	17.5cm*	1.25kg	2.0kg
DHY-03S	Automatic digital TBU with ringing detector, 19" rack mounted	4.5cm (1U)	48.3cm (19" rack width)	17.5cm*	1.30kg	2.1kg
DHY-03T	Twin automatic digital TBU with ringing detector, 19" rack mounted	4.5cm (1U)	48.3cm (19" rack width)	17.5cm*	2.60kg	4.0kg
DHY-03EC	Automatic digital TBU with ringing detector Eurocard model (PCB 10x16cm)	12.9cm (3U)	4.0cm (8E)	19.0cm	150g	500g

Table 4-2 : Physical Specification.

*Depth is measured from the front of the divert button to the back of the remotes connectors.



Accessories

Order Code	Description
DHY-03CON	Convert rack-mounted to free standing
DHY-03SCON	Front panel conversion kit, DHY-03 free standing to DHY-03S 19" rack-mount front
DHY-03TCON	Front panel conversion kit, DHY-03 or DHY-03S, to DHY-03T 19" rack-mount front
DHY-03CONF	Conference cable, 0.5m long
DHY-03RLY	Automatic handset divert relay (for older hybrids, see below)

Table 4-3: Accessories.

Divert Relay Function

The divert relay will disconnect the handset from the line when the call is being handled by the DHY-03. For the DHY-03EC and for later models of the DHY-03 (serial numbers 507 - 581 and 600 onwards) this relay is fitted internally. To disable the divert relay use the serial port to set parameter 2 to just the DTMF select value (default DTMF is * so parameter 2 is 13 or 0D hex). For earlier models (serial numbers 1-506 & 582-599) the function is provided by the optional external divert relay unit (DHY-03RLY) and is enabled by setting parameter 2 to 17 (or 11 hex).

Approvals Information

Sonifex is a BABT approved manufacturing facility with a license to build telecommunications equipment and all telecom products are compliant with BS6301, BS7002, BS415 and CTR21. The following product description is necessary for BABT approval and provides information on the connection and operating conditions of the units.

Manufacturer

Sonifex Limited, 61 Station Road, Irthlingborough, Northants, NN9 5QE, United Kingdom

Equipment Type

DHY-03 telephone balance unit.

Approval File Reference

SON: TJF 25

Functions

The DHY-03 Telephone Balance Unit is suitable for connection to B.T. exchange lines with a parallel connected telephone at the handset port. The hybrid unit is used as a four wire to two wire converter. Incoming calls received at the handset may be diverted to the hybrid unit and produce a 'telephone' signal at the output of the unit. Signals presented at the input are transmitted to the telephone line only. The DHY-03 automatically balances the telephone line.

Specified Systems

The DHY-03 is suitable for connection to any exchange line forming part of a Public Switched Telephone Network, PSTN, or a Relevant Branch system for PSTN lines or any extension. This equipment is not suitable as an extension to a payphone. A definition of Relevant Branch System for PSTN is given in BS6789 : Section 6.1 : 1986 Clause 2.9; including the note to that clause.

Ringer Equivalence Number

The REN=1 marking on the rear of this equipment relates to the performance of the apparatus when used in combination with other items of apparatus.

The REN indicates the maximum number of items that should be connected simultaneously to the line. This equipment may be connected with series apparatus up to REN = 4 maximum.

Accessory Ports

Barrired Ports - The Handset series connection complies with BS6301.

Accessory Ports - Mic/Line Input, Main Output, Conferencing Port, Serial Port & Remotes

Conditions

This apparatus is not designed for use under controlled conditions of temperature and relative humidity.

Series Connection

When connected into the loop connection between the main apparatus and the PSTN, this apparatus introduces a voltage drop at a current of 40mA of 0.300V.

The apparatus should not be used in conjunction with other series connected apparatus such that the aggregate declared voltage drops, together with that of any relevant wiring at 40mA, exceeds 2.0 volts.

Facilities

This apparatus has been approved for use as a telephone hybrid unit (four wire to two wire converter) and for use with a series connected simple telephone. Any other usage will invalidate the approval of the apparatus if as a result it then ceases to comply with the standards against which approval was gained.

Statutory Mark

Approved for connection to telecommunications systems specified in the instructions for use subject to the conditions set out in them.



SONIFEX

www.sonifex.co.uk

t:+44 (0)1933 650 700

f:+44 (0)1933 650 726

sales@sonifex.co.uk

interstage

Phistersvej 31, 2900 Hellerup, Danmark
Telefon 3946 0000, fax 3946 0040
www.interstage.dk



- pro audio with a smile



SONIFEX